



ISTRUZIONE DI MONTAGGIO ASSEMBLY INSTRUCTIONS MONTAGEANLEITUNG INSTRUCTIONS DE MONTAGE

CASSETTA VIRGINIA 146x130 cm p.s. Posb12 Fosb12
GARDEN VIRGINIA 146x130 cm p.s. Posb12 Fosb12
GARTENHAUS VIRGINIA 146x130 cm p.s. Posb12 Fosb12
ABRI DE JARDIN VIRGINIA 146x130 cm p.s. Posb12 Fosb12

Inspection Certificate

Kontrollschein • Bulletin de contrôle • Certificato di controllo •
Certificado de control

Please keep safely!

Bitte gut aufbewahren! • A bien conserver, s.v.p.! • Da conservare! •
¡Para conservar!

English: The house you have purchased was manufactured in accordance with the high quality norms. The building unit has been carefully inspected and packed. In order to avoid possible problems during the assembly carried out by yourself or the building company of your choice, we recommend that you inspect the delivery for its completeness in accordance with the list of pieces before assembly. This inspection must be carried out within 14 days after delivery to your place. Warranty claims are limited to the exchange of defective materials. Defective building parts, which have already been used or painted, are excluded from being replaced. All further claims are excluded! In cases of complaints, please pay attention to the following procedures: Please present this inspection certificate along with the sales receipt to your place of purchase. Only in cases where these documents are presented will the complaint be dealt with quickly and without complications.

Deutsch: Das von Ihnen gekaufte Haus wurde nach der hohen Qualitätsnorm gefertigt. Der Bausatz wurde sorgfältig geprüft und verpackt. Um etwaige auftretende Probleme während des Aufbaus durch Sie oder Ihre Aufbaufirma zu vermeiden, kontrollieren Sie bitte die Lieferung auf Vollständigkeit laut Stückliste vor dem Aufbau. Diese Kontrolle muss innerhalb 14 Tagen nach Anlieferung bei Ihnen erfolgen. Ansprüche auf Gewährleistung beschränken sich auf den Austausch von fehlerhaftem Material. Fehlerhafte Bauteile, die bereits verbaut oder gestrichen wurden, sind vom Umtausch ausgeschlossen. Alle weiteren Ansprüche sind ausgeschlossen! Sollte es zu einer Beanstandung kommen, beachten Sie folgende Vorgehensweise: Legen Sie Ihrem Fachhändler diesen Kontrollschein zusammen mit dem Einkaufsbeleg vor. Nur bei Vorlage dieser Unterlagen ist eine schnelle und problemlose Bearbeitung Ihrer Beanstandung möglich.

Français: La cabane que vous venez d'acheter a été fabriqué en respectant de hautes normes de qualité. L'ensemble de construction a été testé et emballé avec soin. Afin d'éviter des problèmes éventuels pendant la construction par vous-même ou la société de construction mandatée, nous vous prions de bien vouloir vérifier que toutes les pièces ont été fournies selon la liste des pièces avant que vous ne commenciez la construction. Il vous incombe de faire ce contrôle dans les 14 jours après la fourniture. Les revendications en dédommagement se limitent à l'échange de matériel défectueux. Des pièces de construction défectueuses, déjà construites ou peintes, sont exclues de tout échange. Toutes les revendications ultérieures sont exclues ! Si une réclamation avait lieu, veuillez respecter le déroulement suivant : Il vous faudra présenter, à votre commerçant spécialisé, ce bulletin de contrôle avec le récépissé de l'achat. Ce ne sera que moyennant présentation de ces documents qu'un traitement rapide et sans problème de votre réclamation sera possible!

Italiano: La casetta che avete acquistato è stata prodotta secondo le norme di alta qualità. Il kit è stato controllato ed imballato con cura. Per evitare eventuali inconvenienti durante il montaggio, si prega di verificare, prima del montaggio, la completezza della fornitura in base alla distinta dei pezzi. Tale verifica deve essere effettuata entro 14 giorni dalla consegna. Eventuali diritti di garanzia si limitano alla sostituzione di materiale difettoso. Gli elementi difettosi già montati o verniciati sono esclusi dal diritto alla sostituzione. Ogni altro diritto resta escluso! In caso di reclamo, procedere nel modo seguente: presentare questo certificato di controllo unitamente alla prova d'acquisto al rivenditore. Solo in questo modo il Suo reclamo potrà essere evaso rapidamente e senza problemi.

Español: La casa que ha adquirido ha sido fabricado de acuerdo con las normas de alta calidad. La construcción de la unidad ha sido cuidadosamente inspeccionada y embalada. Con el fin de evitar posibles problemas durante la montaje llevada a cabo por usted o la empresa de construcción de su elección, le recomendamos que inspeccione la entrega de acuerdo con la lista de las piezas antes del montaje. Esta inspección deberá realizarse dentro de los 14 días después del parto a su lugar. Las reclamaciones de garantía se limita al intercambio de materiales defectuosos. La construcción de partes defectuosas, que ya han sido utilizados o se pintan, no pueden ser reemplazados. Todas las otras reclamaciones están excluidos! En los casos de quejas, por favor, preste atención a los siguientes procedimientos: Por favor presente este certificado junto con el recibo de venta a su lugar de compra. Sólo en los casos en que estos documentos se presentan a la denuncia se resuelva de forma rápida y sin complicaciones.

To be completed by buyer! (Please use block letters) • Vom Käufer auszufüllen! (Bitte in Druckschrift) • A remplir par l'acheteur! (en lettres d'imprimerie, s'il vous plaît) • Da compilare dall'acquirente! (in stampatello) • Rellena el cliente (en mayusculas por favor) :

Place of purchase • Bezugsquelle • Source
d'achat • Acquistato presso • Lugar de compra :

.....
.....
.....

Sales receipt No. • Kaufbeleg-Nr. • Récépissé n°
• Prova d'acquisto N. • N° recibo:

Delivery date • Lieferdatum • Date de livraison •
Data di consegna • Fecha de entrega:

Buyer's address • Kundenanschrift • Adresse du client • Indirizzo del cliente •
Dirección del cliente:

.....
.....

Telephone • Telefon • Téléphone • Telefono:

Sales receipt date • Kaufbeleg-Datum • Date du récépissé • Data prova

d'acquisto • Fecha recibo :

Forwarder: Pick-up Others • Durch: Spedition Selbstabholer •

Par: Transporteur Propres moyens • Tramite: Spedizioniere Mezzo proprio

• Entrega: Transporte organizado transporte de cliente

Description of complaint • Schilderung der Beanstandung • Description de la réclamation • Descrizione del reclamo •
descripción de queja: **(Please keep the parts which are the object of the complaint until the complaint is settled! • Bitte die**
reklamierten Teile aufheben, bis die Reklamation erledigt ist! • Veuillez garder les pièces contestées jusqu'à ce que la réclamation soit
traitée définitivement! • Si prega di conservare i pezzi contestati del reclamo!) • Por favor mantiene todas detalles
reclamadas hasta que la queja se ha resuelto.

INDICAZIONI GENERALI

Gentile Cliente,

la ringraziamo per aver scelto la nostra casetta in legno.

E' importante leggere accuratamente le istruzioni prima di dare inizio alle operazioni di montaggio del prodotto, in tal modo eviterà qualsiasi problema e perdita di tempo.

Consigli:

- Conservare il kit in luogo asciutto e non appoggiato direttamente sul pavimento, mantenendolo protetto da agenti atmosferici (acqua, sole ecc.) fino al montaggio definitivo. Non conservare il prodotto in ambienti riscaldati.
- Nella scelta del luogo in cui sarà posizionata la casetta, prestare attenzione a che non sia esposta a condizioni atmosferiche estreme (zone esposte a vento forte).

Garanzia:

La vostra casetta è stata realizzata con pregiato legno di abete rosso nordico e viene consegnata non trattata. Qualora, nonostante il nostro accurato controllo in fabbrica, dovessero sorgere reclami sarà necessario presentare al negoziante il certificato di controllo compilato insieme alla fattura d'acquisto.

Esclusioni:

- Il legno è una materia prima naturale e pertanto le contestazioni relative al suo naturale comportamento non rientrano nella garanzia.
- Reclami relativi al materiale non vengono accettati una volta verniciato.
- Nodi nel legno.
- Scolorimenti del legno che non influiscono sulla durata.
- Crepe / fessure non passanti che non compromettono la costruzione.
- Deformazioni del legno, a condizione che possa ancora essere lavorato.
- Sui lati non visibili del tavolame del tetto e del pavimento sono ammesse parti non piallate; sono inoltre ammesse differenze di colore e di smusso.
- Reclami successivi dovuti a montaggio non conforme o cedimento della struttura della casetta a causa di fondamenta errate sono esclusi.

Le rivendicazioni di garanzia sono limitate alla sostituzione del materiale difettoso, ogni altra rivendicazione è esclusa.

VERNICIATURA, MANUTENZIONE E SMALTIMENTO

Il legno è un prodotto naturale e si muove in modo variabile. Caratteristiche quali venature grosse e sottili, sfumature e cambiamenti di colore nonché nodi sono dovuti alla crescita dell'albero. Sono del tutto normali nei legni che crescono all'aperto, e pertanto non sono da considerare difetti ma piuttosto una caratteristica del legno naturale.

Per la verniciatura, usare attrezzi e vernici di qualità e rispettare le istruzioni di sicurezza e applicazione del produttore della vernice. Non verniciare in pieno sole o in caso di pioggia. Farsi consigliare dettagliatamente dal venditore sulla protezione di legni di conifera trattati. Con una regolare verniciatura aumenterete notevolmente la durata della vostra casetta in legno. Consigliamo un'ispezione semestrale del prodotto.

Lubrificare con regolare frequenza le parti mobili quali serratura, cerniere e catenacci facendo attenzione a non imbrattare le parti circostanti.

A fine vita del prodotto provvedere a consegnare la **casetta** direttamente all'ECOCENTRO nel cassonetto del **LEGNO**. Oppure, nei comuni dove è previsto, mediante il ritiro rifiuti ingombranti.

DE

GENERELLES

Sehr geehrter Kunde,

es freut uns, dass Sie sich für unser Elementhaus entschieden haben!

Es ist wichtig, diese Aufbauanleitung vollständig durchzulesen, bevor Sie mit dem Aufbau Ihres Elementhauses beginnen! So vermeiden Sie Probleme und unnötigen Zeitverlust.

Tipps:

- Lagern Sie den Bausatz bis zur endgültigen Montage trocken und nicht direkt auf dem Erdboden, geschützt vor Witterungseinflüssen (Nässe, Sonneneinwirkung, etc.). Ware bitte nicht in einem geheizten Raum aufbewahren!
- Achten Sie bei der Standortwahl darauf, dass das Elementhaus nicht extremen Witterungsbedingungen (Gebiete mit starkem Wind) ausgesetzt ist.

Gewährleistung

Ihr Elementhaus besteht aus hochwertigem nordischen Fichtenholz und wird unbehandelt geliefert. Wenn es trotz unserer sorgfältigen Werkskontrolle zu Reklamationen kommen sollte, legen Sie Ihrem Fachhändler den ausgefüllten Kontrollschein mit Ihrer Einkaufsrechnung vor!

Abweichungen, die keinen Reklamationsgrund darstellen:

- Holz ist ein Naturprodukt, daher gehören die naturgegebenen Beanstandungen nicht unter Garantie.
- Materialreklamationen werden nicht akzeptiert, wenn bereits ein Anstrich erfolgte!
- Äste, die mit dem Holz fest verwachsen sind.
- Holzverfärbungen, ohne das dadurch die Lebensdauer beeinflusst wird.
- Risse /Trockenrisse, die nicht durchgehend sind und nicht die Konstruktion beeinflussen.
- Verdrehungen des Holzes, vorausgesetzt es lässt sich noch verarbeiten.
- An den nicht sichtbaren Seiten von Dachbrettern können die Bretter ungehobelt sein, es können Farbunterschiede und Baumkanten vorkommen.
- Spätere Reklamation durch unsachgemässe Montage, Absacken des Elementhauses durch unsachgemässe Fundamente und Gründungen sind ausgeschlossen.
- Für Schäden, die aus falscher Pflege und unsachgemäßem oder fehlendem Anstrich resultieren (z.B. Verzug von Teilen), können keine Garantieansprüche erhoben werden.

Ansprüche auf Gewährleistung beschränken sich auf den Austausch von fehlerhaftem Material. Alle weiteren Ansprüche sind ausgeschlossen!

LACKIERUNG, WARTUNG UND ENTSORGUNG

Holz ist ein Naturprodukt und arbeitet unterschiedlich. Merkmale wie grobe und feine Maserungen, Farbschattierungen und Veränderungen sowie Verwachsungen haben Ihren Ursprung im Wuchs des Baumes. Sie sind bei Hölzern, die in der freien Natur wachsen, normal und deshalb nicht als Fehler, sondern vielmehr als Eigentümlichkeit des Naturwerkstoffes Holz anzusehen.

Beim Anstrich benutzen Sie hochwertiges Werkzeug und Farbe, beachten Sie die Sicherheits- und Verarbeitungshinweise des Farbenherstellers. Streichen Sie nie in praller Sonne oder beim regnerischen Wetter. Lassen Sie sich ausführlich bei Ihrem Fachhändler über den Holzschutz für Nadelhölzer beraten. Durch einen regelmässigen Anstrich beeinflussen Sie im Wesentlichen die Lebensdauer Ihres Elementhauses. Wir empfehlen Ihnen auch eine halbjährliche Inspektion des Elementhauses.

Schmieren Sie bewegliche Teile wie Schlösser, Scharniere und Schließen mit regelmäßiger Frequenz, und achten Sie darauf, dass die umgebenden Teile nicht schmutzig werden.

Am Ende der Lebensdauer des Produkts, gehen Sie, um die Haus direkt auf die ökologische Insel zu liefern, in der hölzernen Mülleimer. Oder in den Gemeinden, in denen es geplant ist, durch die Sammlung von Sperrmüll.

FR

GÉNÉRALITÉS

Cher client,

Nous sommes heureux que votre choix se soit porté sur notre maisonnette!

Il est important de lire entièrement cette notice de montage avant de commencer la construction de votre maisonnette! Vous vous éviterez ainsi des problèmes et des pertes de temps inutiles.

Conseils:

- Avant son montage définitif, entreposez le kit de construction au sec et pas directement sur la terre, en le protégeant contre les intempéries (humidité, rayonnement du soleil, etc.). Ne pas conserver la merchandise dans un local chauffé!
- Au moment de choisir l'endroit de montage, veillez à ce que le maisonnette ne soit pas exposée à des conditions atmosphériques extrêmes (zones exposées à des vents forts).

Garantie

Votre maisonnette est réalisée en bois d'épicéa nordique de haute qualité et elle vous est livrée non traitée. Si elle devait donner lieu à des réclamations, malgré les soins apportés à notre contrôle en usine, nous vous demandons de remettre à votre revendeur spécialisé le bon de contrôle rempli et votre facture d'achat!

Ecarts qui ne constituent pas un motif de réclamation:

- Le bois est un produit naturel, ce qui fait que les réclamations reposant sur des phénomènes naturels ne tombent pas sous le coup de la garantie.
- Les réclamations concernant les matériaux ne sont pas acceptées si une peinture a déjà été appliquée!
- Noeuds qui sont inhérents au bois.
- Décolorations du bois qui n'exercent pas d'influences sur la durée de vie.
- Fissures / fentes de retrait qui ne sont pas traversantes et qui n'exercent pas d'influences sur la construction.
- Déformations du bois, sous réserve qu'il puisse encore être mis en oeuvre.
- Sur les faces non visibles des planches du toit et du plancher, il se peut que les planches ne soient pas rabotées, on peut observer des différences de couleur et des flaches.
- Une réclamation tardive résultant d'un montage incorrectement réalisé, d'un affaissement du maisonnette par suite de fondations et de soubassements incorrectement réalisés, est exclue.

Les recours en garantie se limitent au remplacement du matériel défectueux. Tous les autres recours sont exclus!

PEINTURE, ENTRETIEN ET ÉLIMINATION

Le bois est un produit naturel qui travaille de façon variable. Des caractéristiques telles que les madrures grossières et fines, les nuances de couleurs et les modifications, de même que les imbrications, ont leur origine dans la croissance du bois. Dans le cas de bois qui poussent en pleine nature, ces caractéristiques sont normales et ne doivent par conséquent pas être considérées comme des défauts mais, au contraire, comme une particularité de ce matériau naturel qu'est le bois.

Pour la peinture, n'utilisez qu'un outillage et une peinture de haute qualité, et respectez les consignes de sécurité et de mise en oeuvre du fabricant de peintures. Ne peignez jamais en plein soleil ou lorsque le temps est à la pluie. Faites-vous conseiller de façon détaillée par votre revendeur spécialisé quant à la protection à utiliser pour les conifères traités. En refaisant régulièrement la peinture, vous augmentez sensiblement la durée de vie de votre maisonnette. Nous vous conseillons également une inspection semestrielle de votre maisonnette.

Lubrifier les pièces mobiles telles que les serrures, charnières et chaînes avec une fréquence régulière, en veillant à ne pas enduire les parties environnantes.

À la fin de la vie du produit, procéder à la livraison du chalet directement à l'île écologique, dans la benne en bois. Ou, dans les municipalités où il est prévu, par la collecte des déchets encombrants.

EN

GENERAL GUIDELINES

Dear Customer,

thank you for choosing this Garden Shed. **It's important to read carefully the instructions before commencing the installation of the product**, thus avoid any problem and loss of time.

Tips:

- Store the kit in a dry place, not directly on the floor, and keep it protected from the elements (water, sun etc.) until final installation. Do not store the product in a heated room.
- When selecting the place where the shed will be located, please take care that it is not exposed to extreme weather conditions (such as to strong wind).

Warranty:

Your Garden Shed is made from high quality Nordic spruce and is delivered untreated. If arise complaints despite our thorough factory inspection, the compiled inspection certificate together with the purchase invoice must be presented to the dealer.

Exclusions:

- Wood is a natural material and, therefore, disputes relating to its natural behavior are not covered by the warranty.
- Complaints relating to the material will not be accepted once painted.
- Knots in the wood.
- Discolorations of wood that do not affect its duration.
- Cracks / non-through-cracks that do not affect the construction stability.
- Deformations of the timber, provided that it can still be worked.
- On the not visible sides of planks in the roof and floor, not planed parties are permitted; in the same parties they are also permitted different colors and chamfer.
- Subsequent claims due to non-conforming assembly or failure of the structure due to incorrect foundations will not be accepted.

Warranty claims are limited to the replacement of defective material, any other claim is excluded.

PAINTING, MAINTENANCE AND DISPOSAL

Wood is a natural product and moves in a variable way. Features such as large and subtle veins, nuances and color changes, and knots, are due to the growth of the tree. They are normal in the woods that grow outdoors and, therefore, should not be considered defects but rather natural wood characteristics.

For painting, please use quality tools and paints and respect the safety instructions and tips application of the paint manufacturer. Do not paint in direct sunlight or in case of rain and be advised in detail by the seller about treated softwoods protection. Having been properly painted substantially increase the duration of your Garden Shed. We recommend bi-annual inspection of the product.

Lublify moving parts such as locks, hinges and chains with regular frequency, making sure not to smear the surrounding parts.

At the end of the life of the product, proceed to deliver the cottage directly to the ecological island, in the wooden dumpster. Or, in the municipalities where it is planned, through the collection of bulky waste.

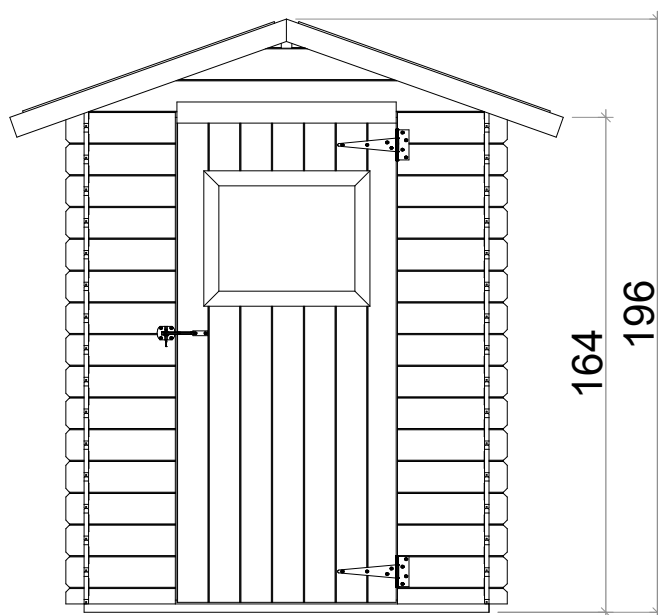
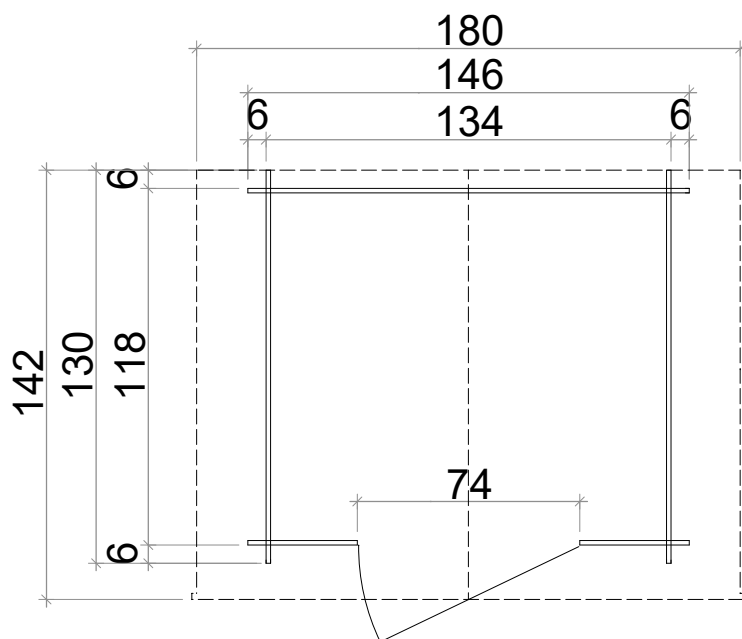

IT

AVVERTENZA: prima del montaggio scaricare la struttura e riporla in luogo livellato ed asciutto avendo cura di coprirla con il telo in dotazione all'imballo.

EN

WARNING: before assembly download the structure and store it in a dry and leveled place also take care to cover it with the tarp packaging supplied.

DE

HINWEIS: Bitte die Lieferung vor der Montage an einem trockenen und ebenen Ort akklimatisieren. Achten Sie darauf, dass die Palette mit einer Plane abgedeckt und vor Feuchtigkeit geschützt ist.

FR

AVERTISSEMENT: avant l'assemblage de la structure télécharger et stocker dans un endroit sec et nivelé en veillant également à le couvrir avec l'emballage fourni.







SCHEDA PER RIPRISTINO ART. 62493

CASSETTA VIRGINIA BH16 p.s. finestrata

dim. 146x130 cm

CLIENTE:

pz	descrizione	dimensione	cod.
5	profilo mass. impr. (pavimento)	35x35x1340 mm	75314E
2	foglio OSB3 (pavimento)	573x1310x12 mm	79087

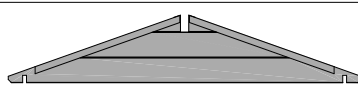
2	½ perlina abete grezzo (pareti)	15x52,5x363 mm		78310B
1	½ perlina abete grezzo (pareti)	15x52,5x1460 mm		78301B
30	perlina abete grezzo (pareti)	15x105x1300 mm		78329B
15	perlina abete grezzo (pareti)	15x105x1460 mm		78300B
30	perlina abete grezzo (pareti)	15x105x363 mm		78309B
2	perlina abete grezzo sagomate (pareti)	15x105x1300 mm		78334B
2	timpano			82006
1	profilo abete grezzo (trave copertura)	35x68x1400 mm		78173B
2	profilo abete grezzo (trave copertura)	28x28x1095 mm		78403B
4	profilo abete grezzo (fissaggio angoli)	28x28x1670 mm		78108B
2	profilo abete grezzo (fermafascione)	28x28x500 mm		78098B
4	foglio OSB3 (copertura)	700x950x12 mm		79088
1	rotolo guaina	1000x7500 mm		05592
6	profilo pino impregnato (fermaguaina)	10x30x900 mm		82001B
2	profilo abete grezzo (fascione)	20x70x970 mm		78131B
1	porta singola finestrata	725x1615 mm		82053
1	finestra	448x550 mm		81917
1	plexiglas	408x510x2 mm		82537
1	profilo abete grezzo (coprifilo porta)	12x70x725 mm		78095B
1	profilo abete grezzo (sembrana)	12x70x845 mm		78096B
2	profilo abete grezzo (sembrana)	12x70x1600 mm		78105B
1	kit ferramenta			26284

Spuntare l'articolo da ripristinare e indicare le quantità necessarie, quindi fare la scansione o la foto della scheda e allegare alla richiesta di ripristino.

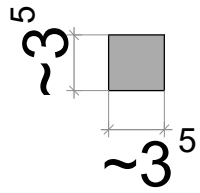

5x

A

134 cm

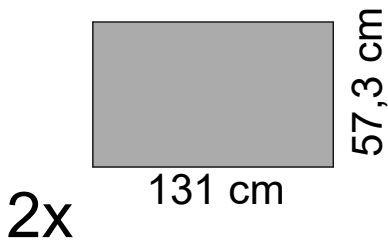

B

2x

131 cm

57,3 cm

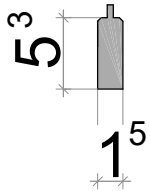

2x

C

36,3 cm



1x

D

146 cm

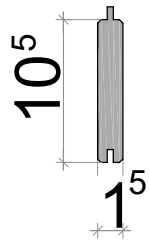

30x

E

36,3 cm



30x

F

130 cm



15x

G

146 cm

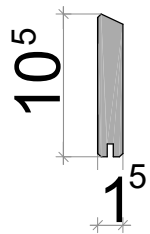
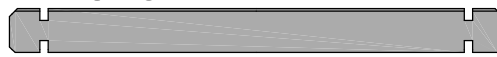



2x



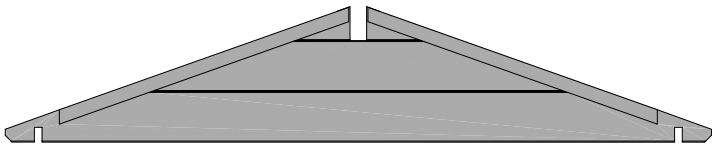

H

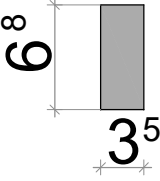
130 cm

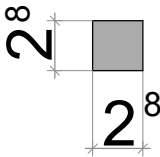

	2x	cod. 82006	
--	----	---------------	--

	1x	I	140 cm 
---	----	---	--

	4x	J	109,5 cm 
	4x	K	167 cm 
	2x	L	50 cm 

	4x	M	
---	----	---	--

1x

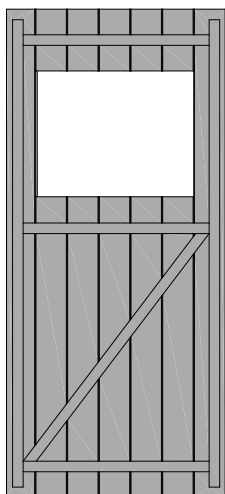

cod.
82053

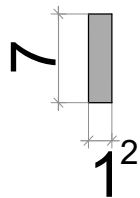

1x

N

72,5 cm

1x

O

84,5 cm

2x

P

160 cm

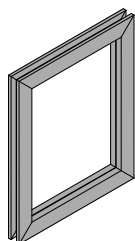

1x

cod.
81917

45x55 cm

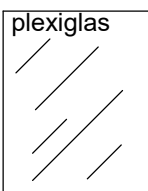

1x

cod.
82537

40,8x51 cm

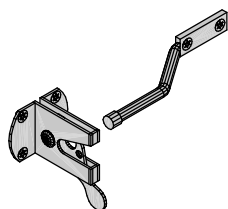

1x

cod.
25589

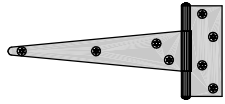

2x

cod.
75132

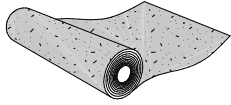

cod.
05592

750 cm

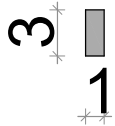

6x

cod.
82001

90 cm

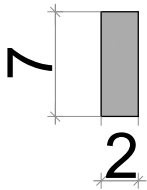

2x

cod.
78131

97 cm



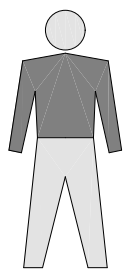

x2

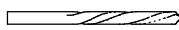
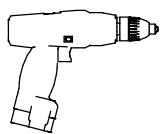

Ø 3 mm

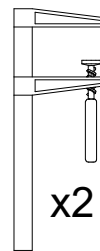
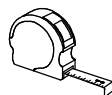
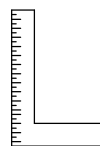
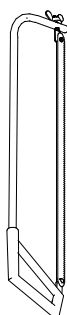

x2

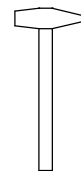

cod.
21080
Ø 5x90 mm

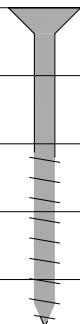

4x

cod.
21050
Ø 4x50 mm

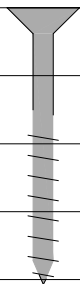

12x

cod.
21045
Ø 4x40 mm

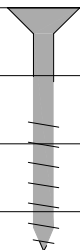

138x

cod.
20020
Ø 4x35 mm

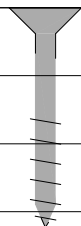

6x

cod.
20027
Ø 3,5x20 mm

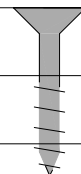

73x

cod.
20160
35 mm



126 gr
126x
1 gr/pz

cod.
05579
13 mm



50 gr
80x
0,625 gr/pz

1

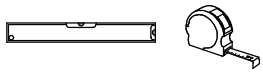

5x

A

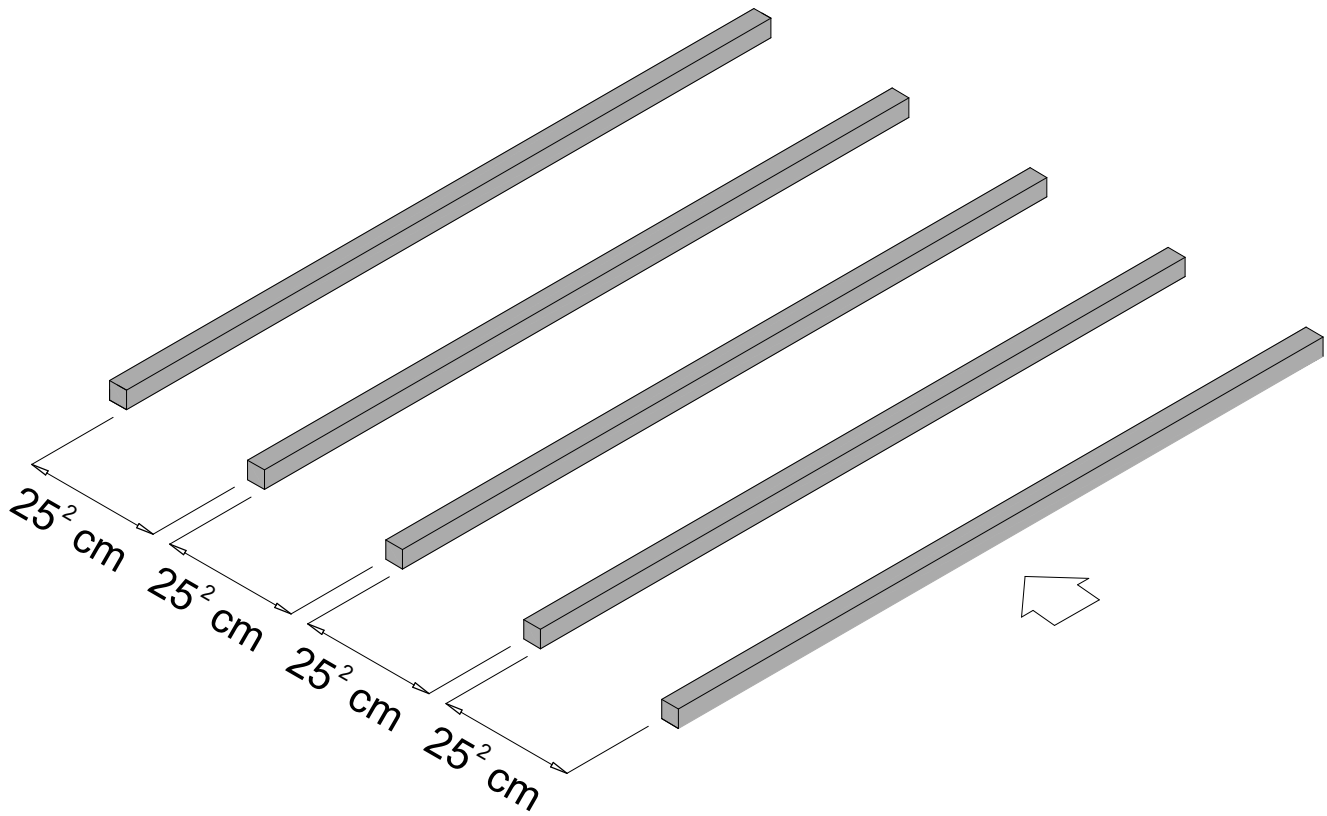
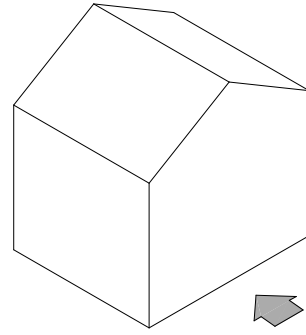

2

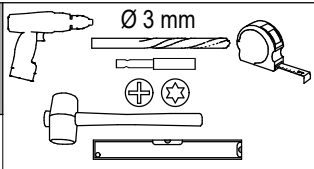

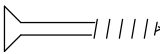

2x C

1x D

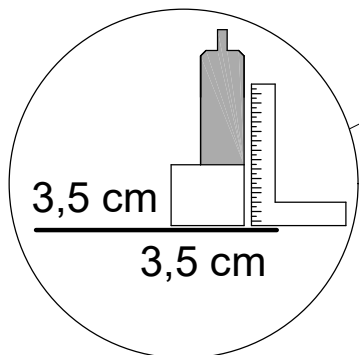
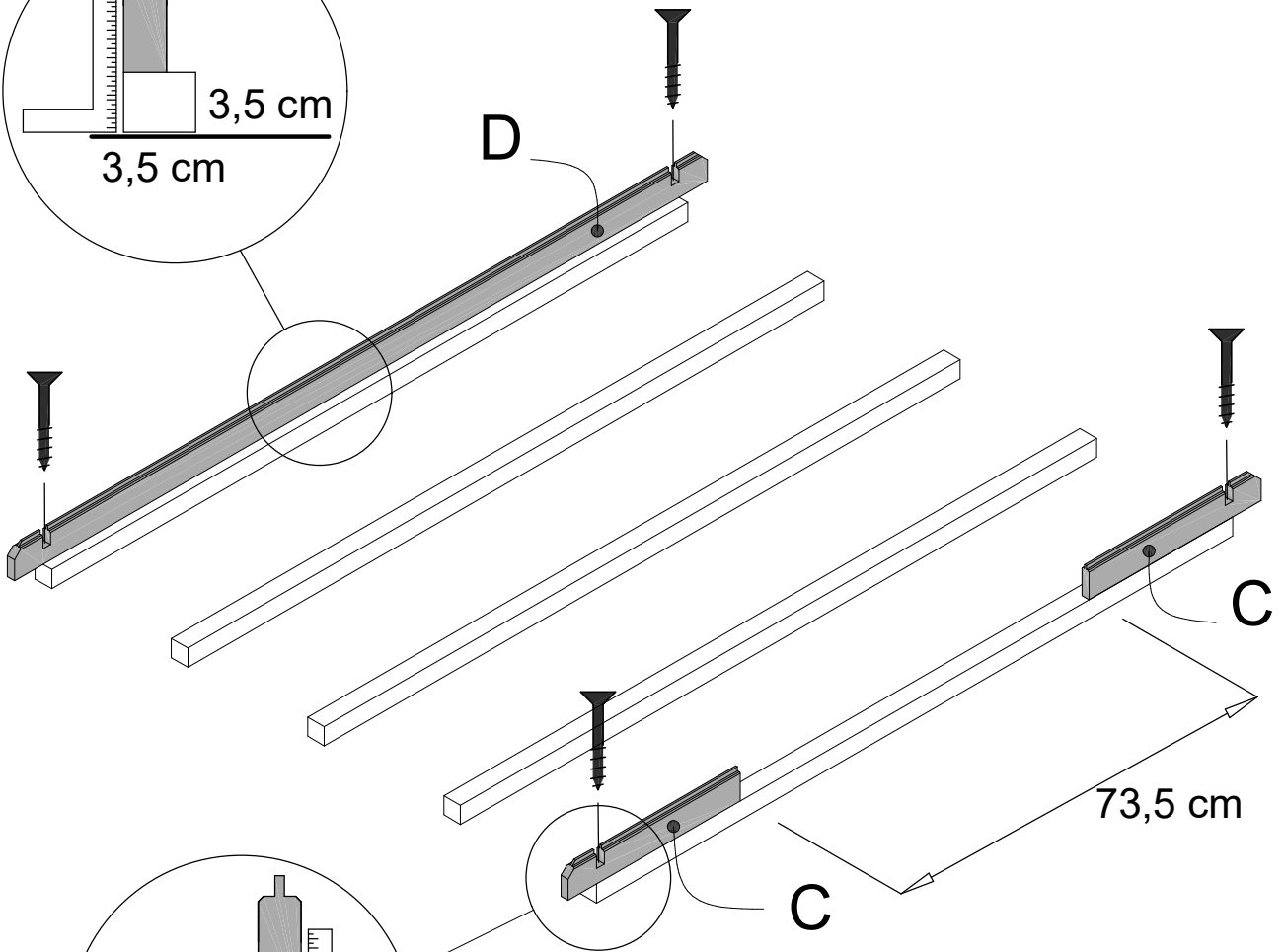
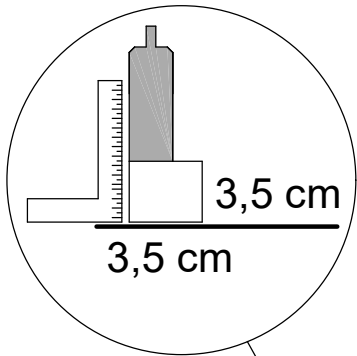
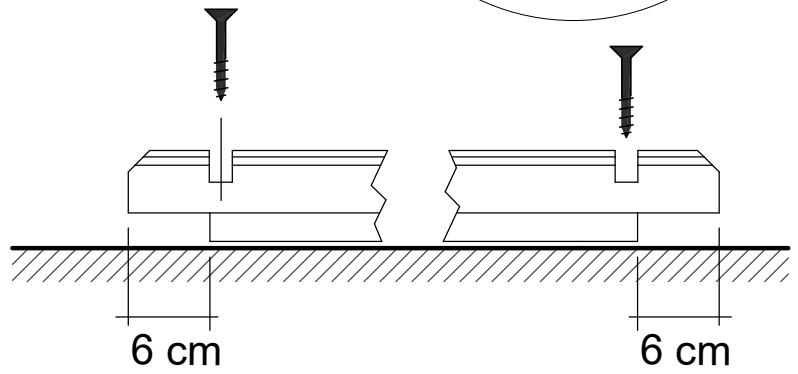
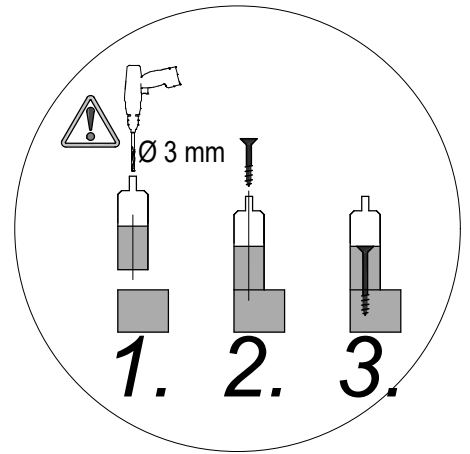
4x  cod. 21050



3  Ø 3 mm  

2x **E**

4x **F**

1x **G**

4x **K**

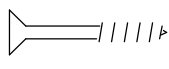
12x  cod. 21045

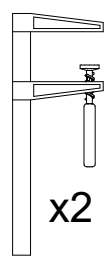
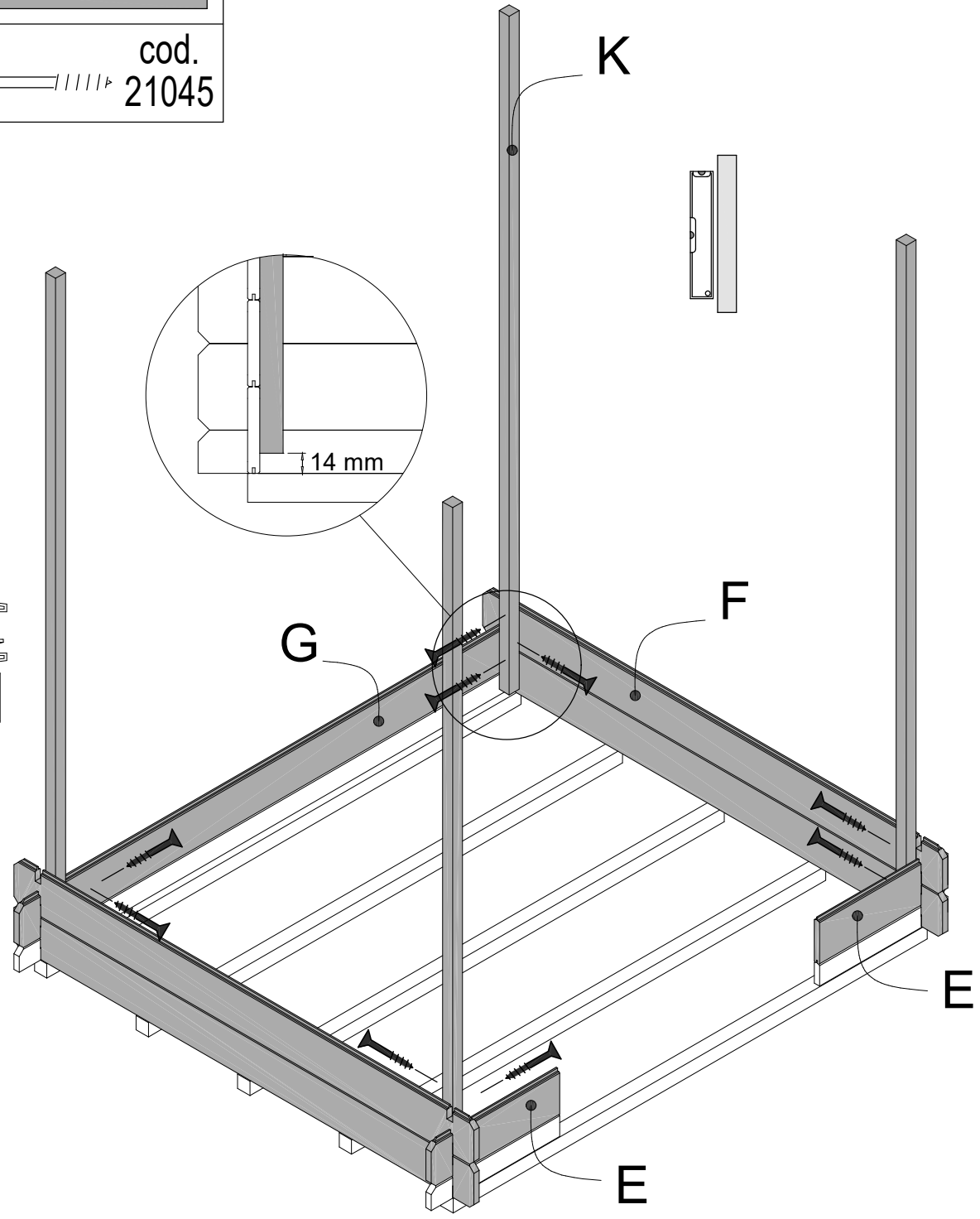
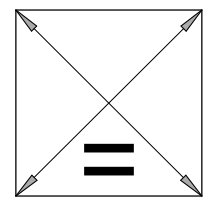
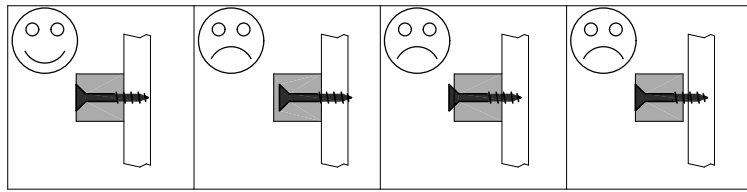

x2

4

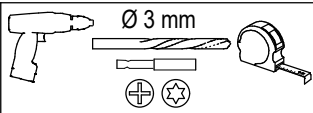

Ø 3 mm



28x E



26x F



F

14x G



G

2x H



H

112x

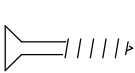

cod. 21045

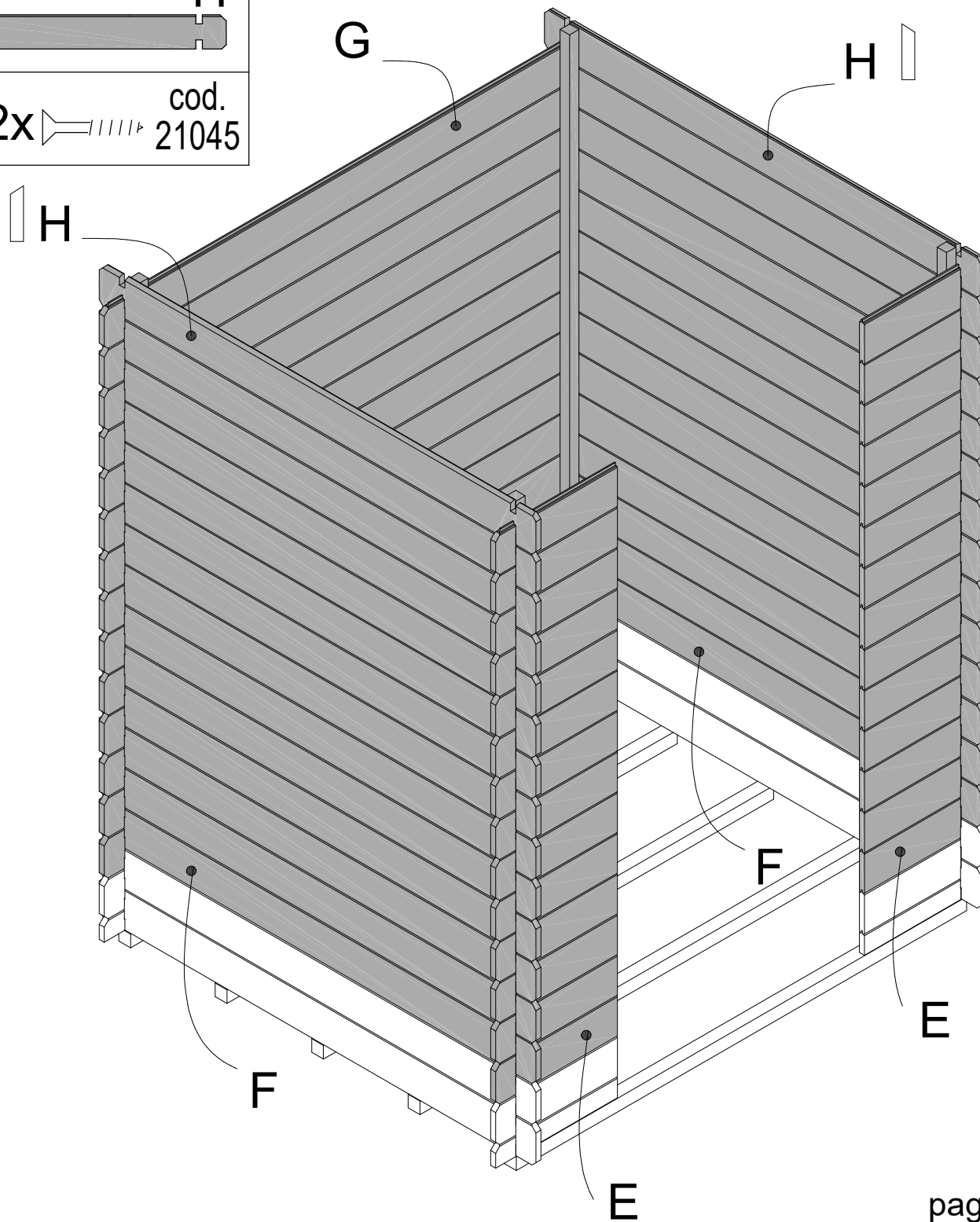
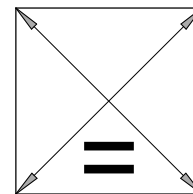
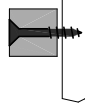
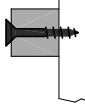
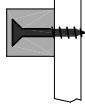
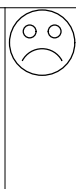
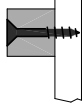
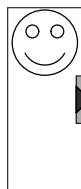

5

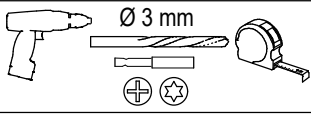

2x

cod.
82006

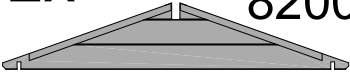

4x

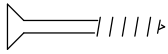

cod.
21050

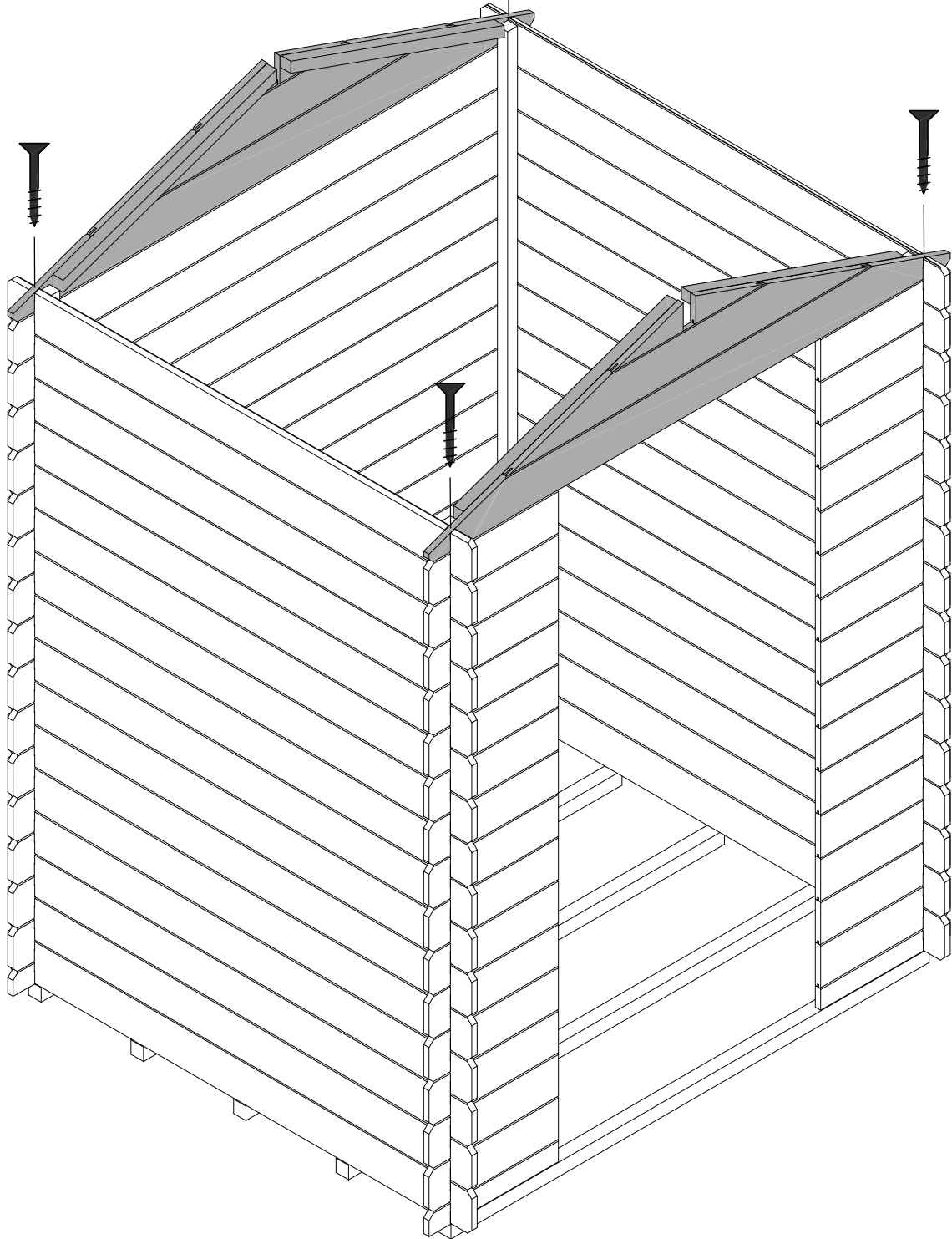
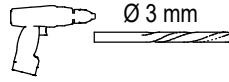

6

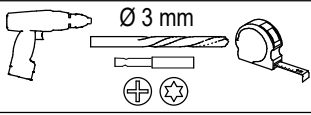

2x

J



8x

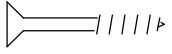

cod.
21045

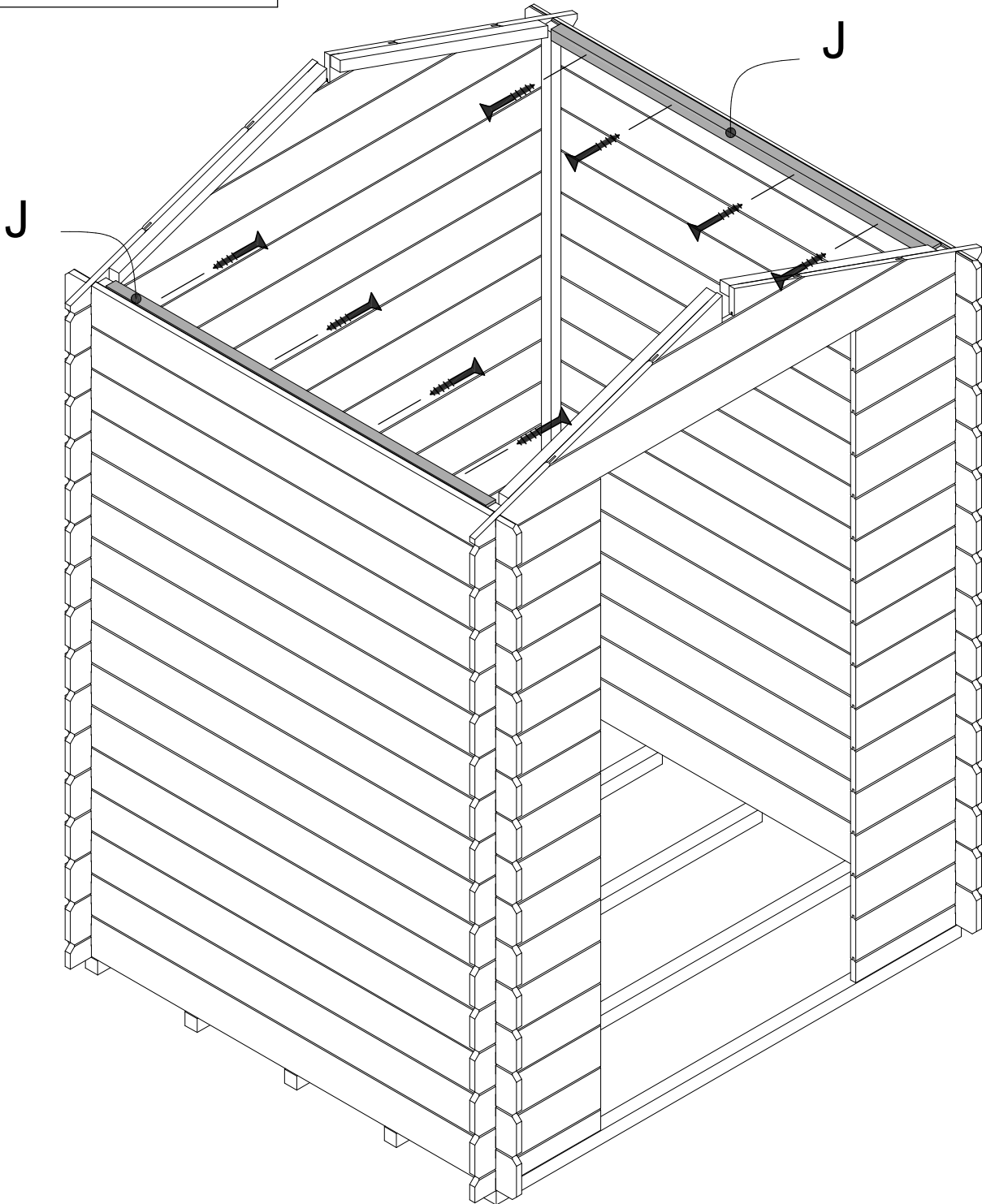

7

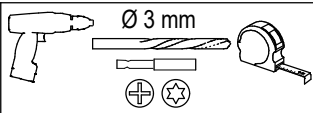

1x



1

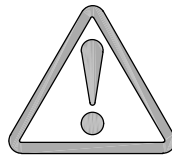

4x

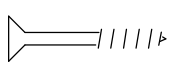

cod.
21050

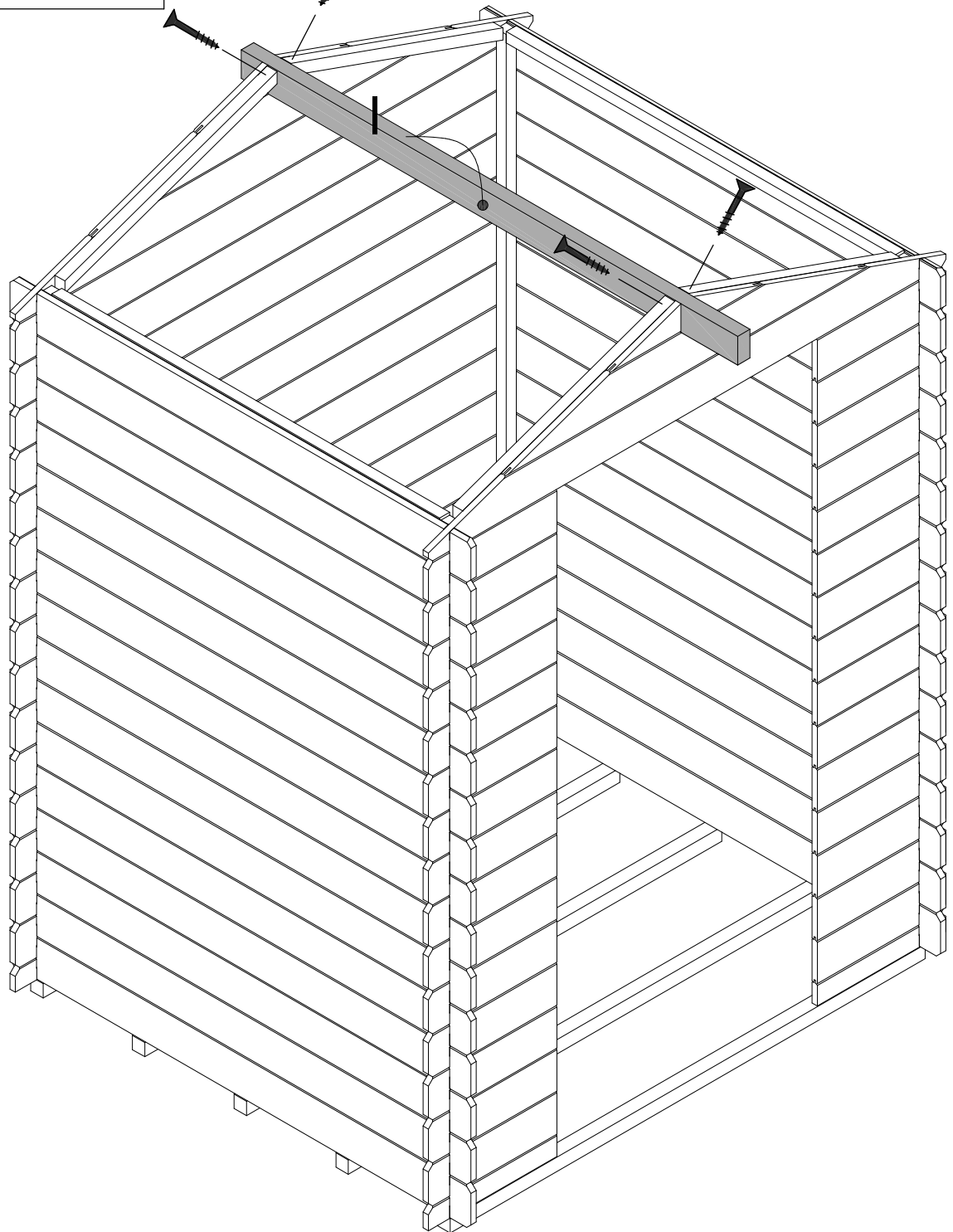
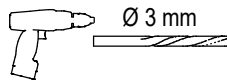

8

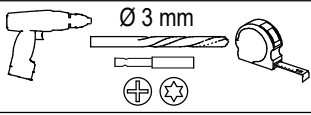

2x

J



4x

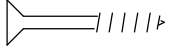

cod.
21080

J

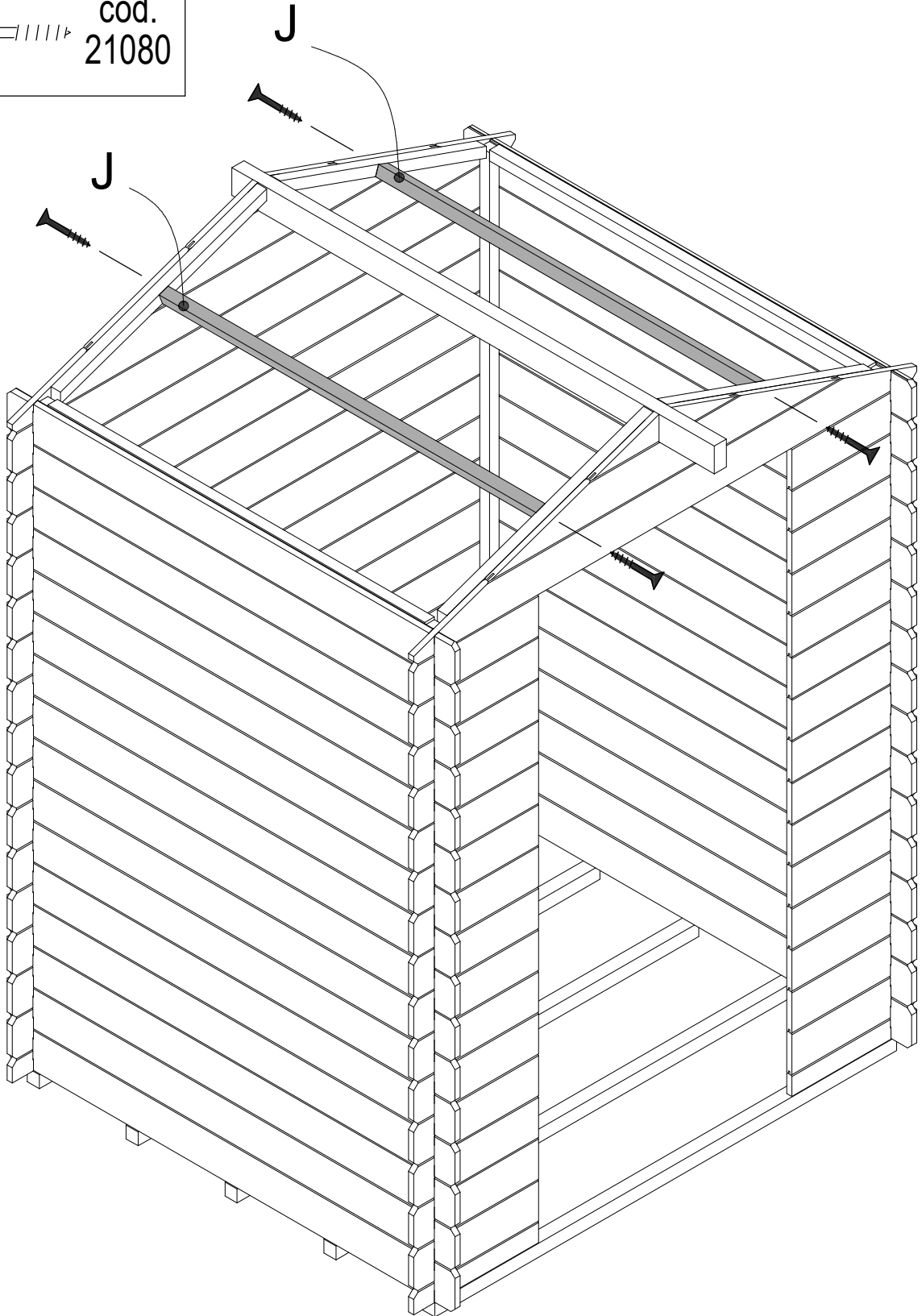

9

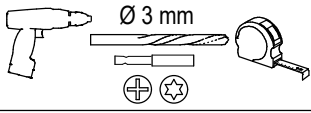

Ø 3 mm

4x M



72x



cod.
20160



$d1=d2$

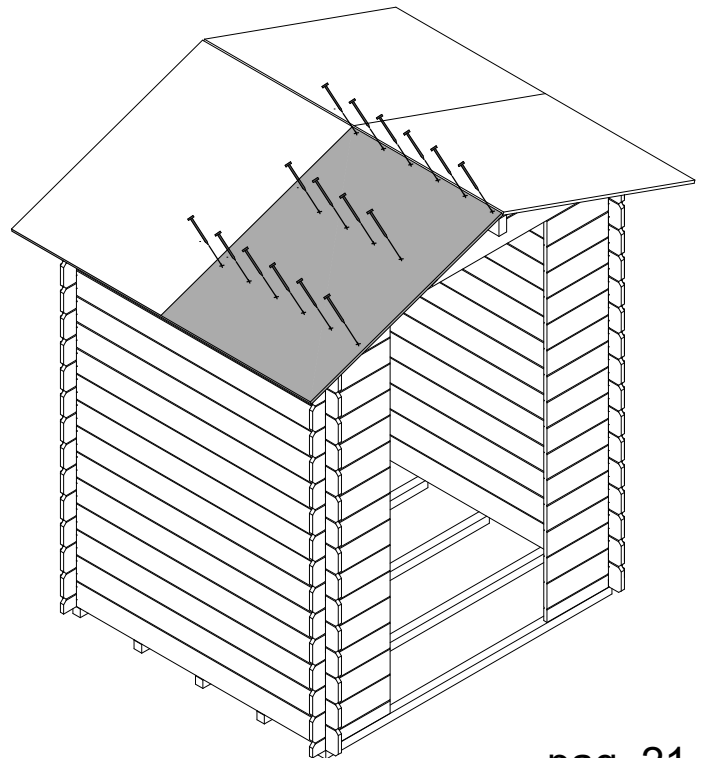
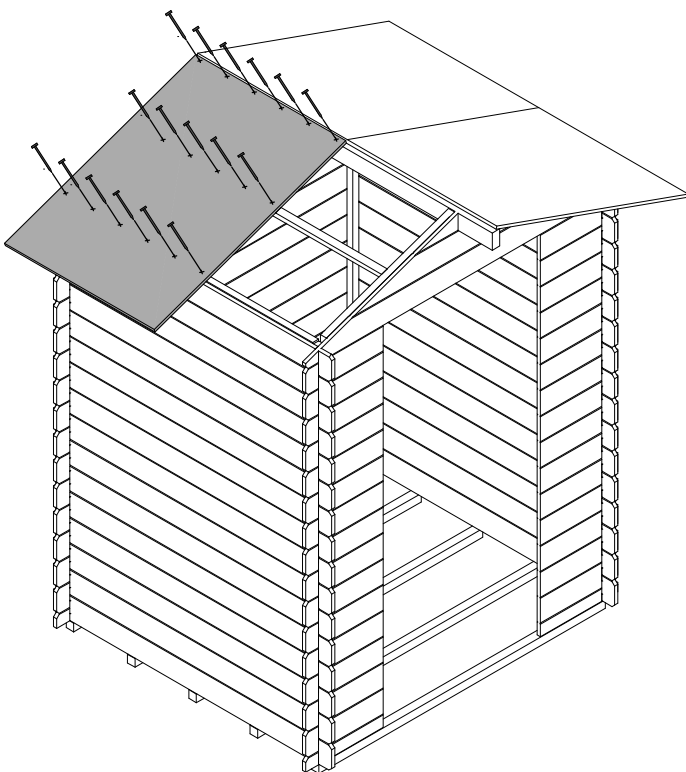
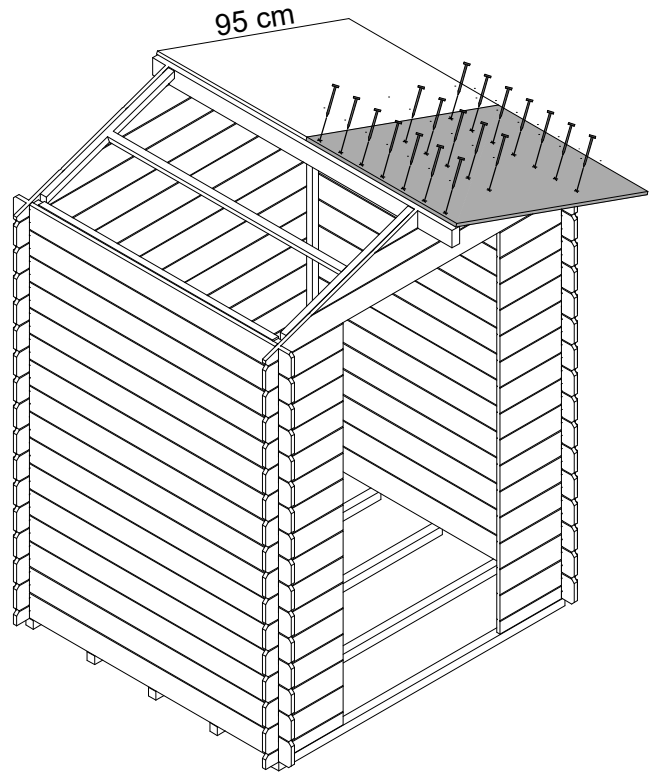
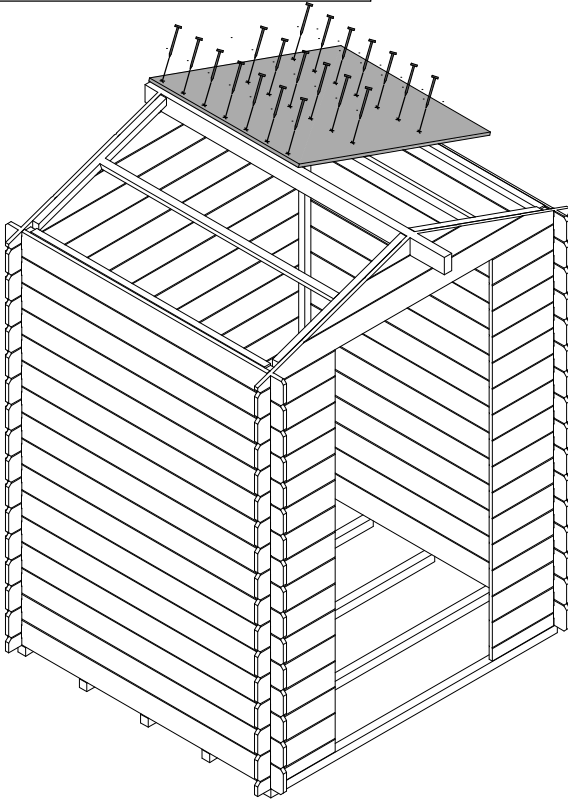
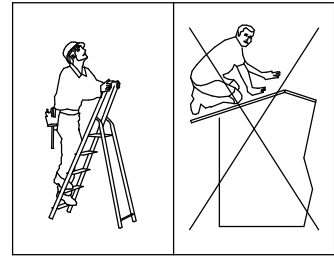
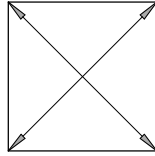

10

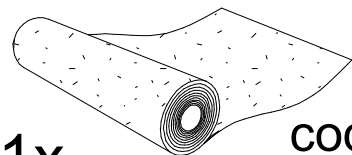
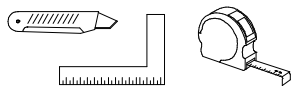

1x

cod.
05592

cod.
05592

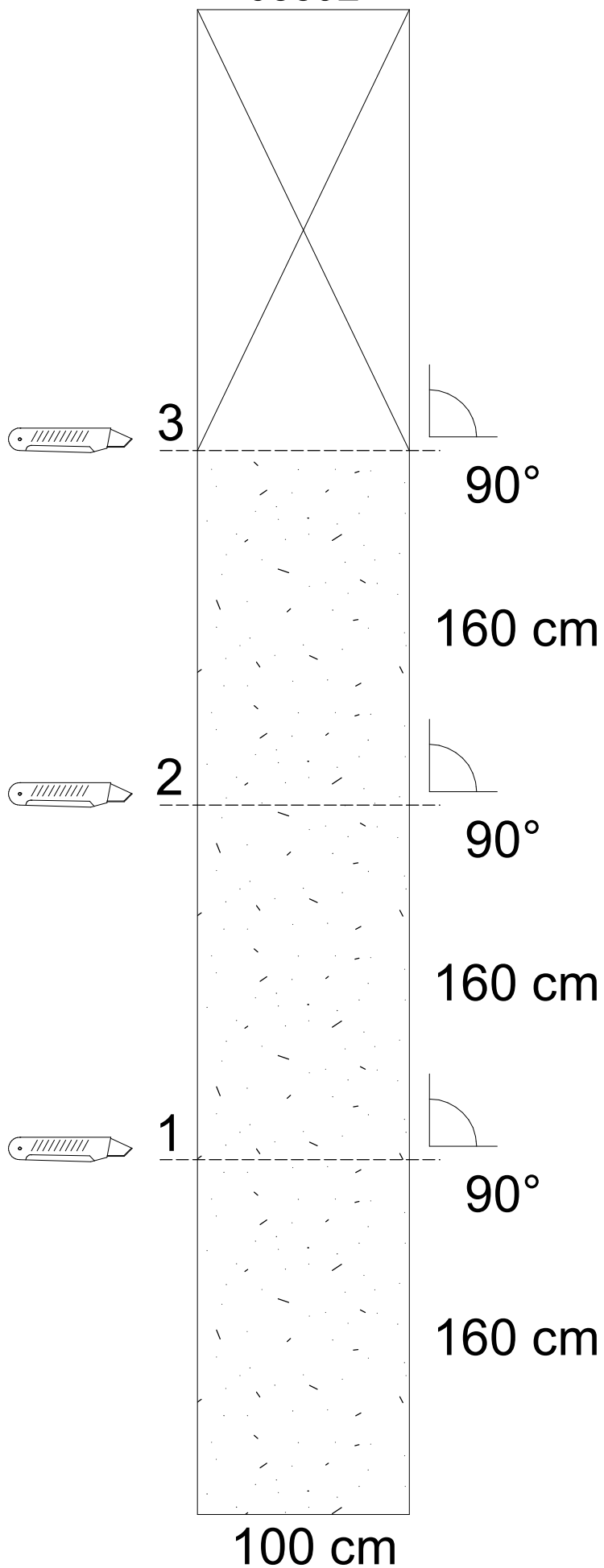

11

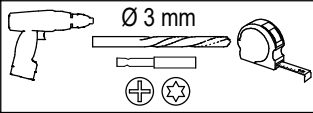

2x L

6x  cod. 20020

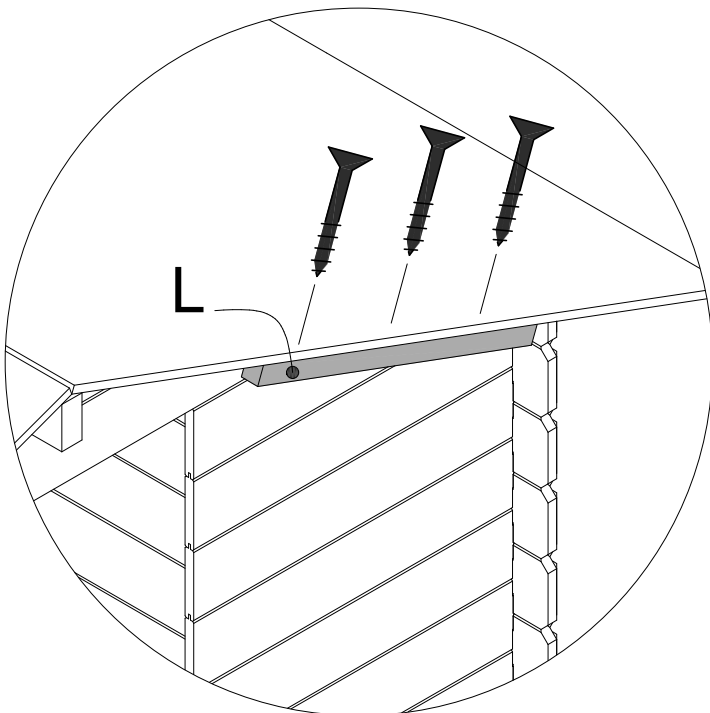
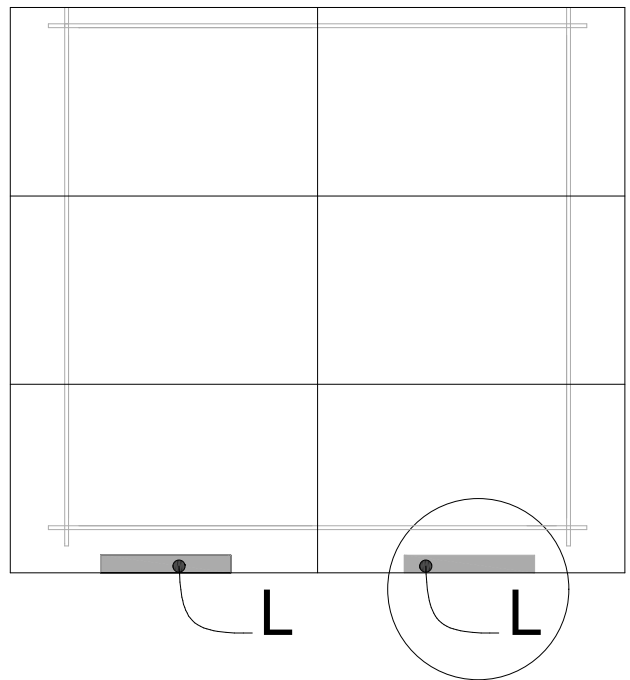
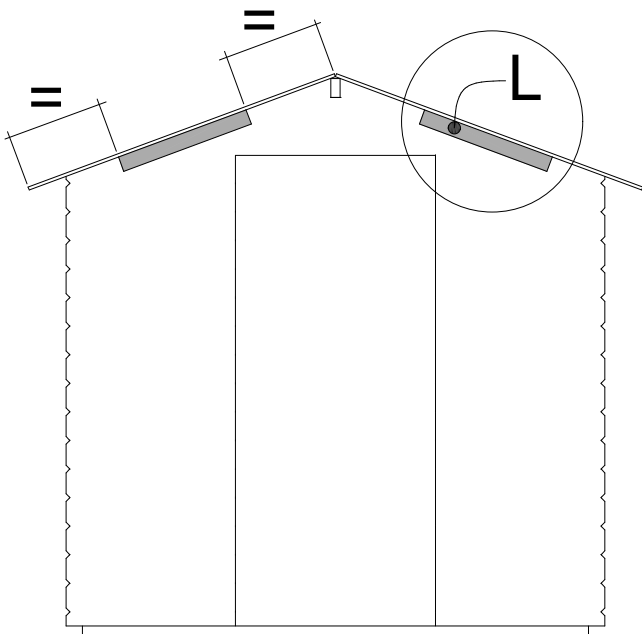
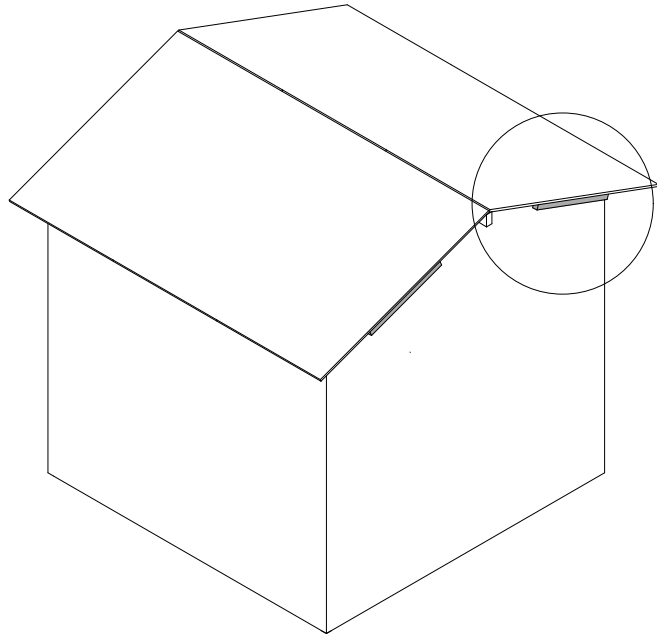

12

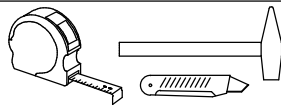

3x 160 cm

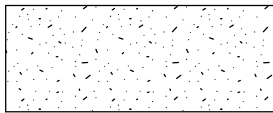

80x



cod. 05579

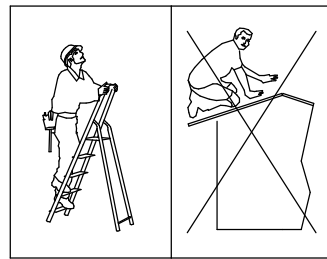

x4

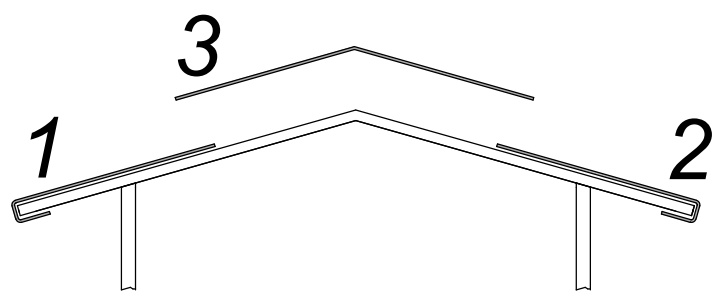
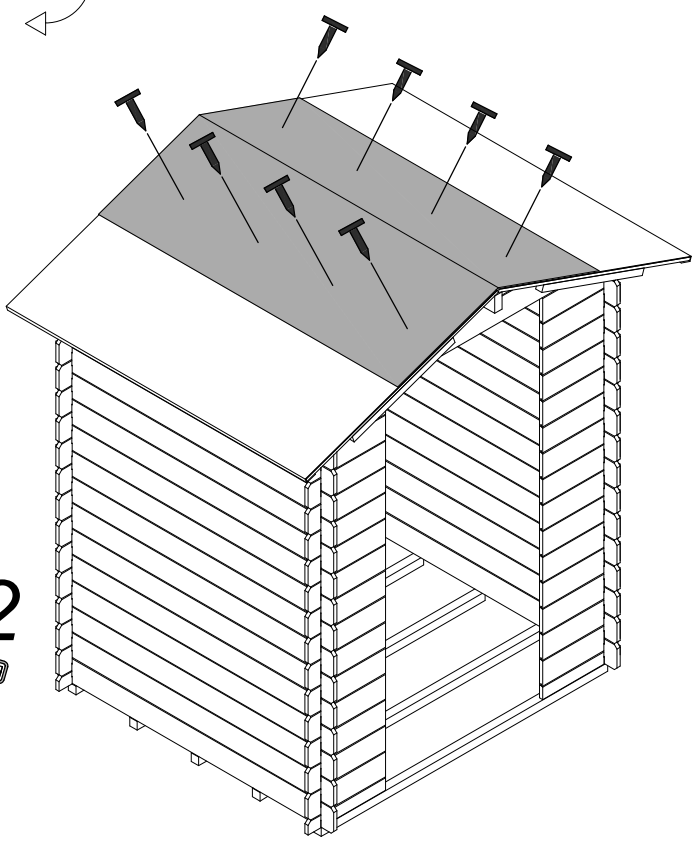
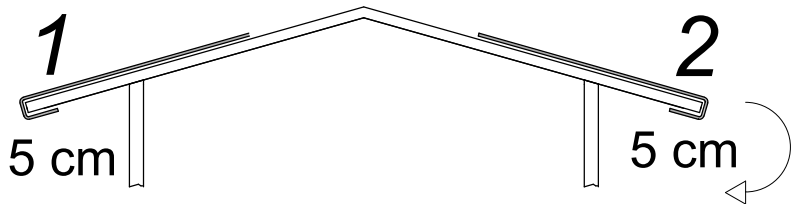
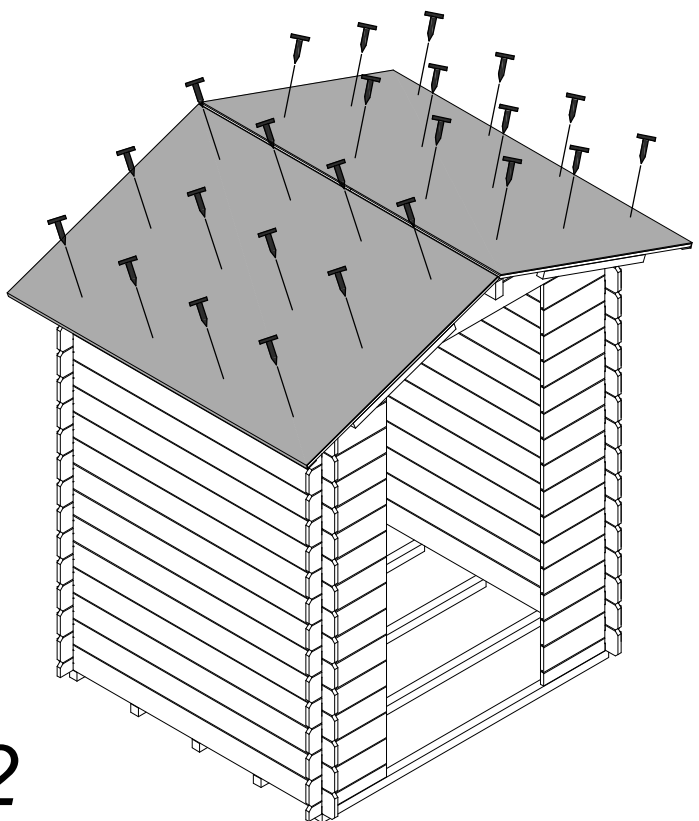
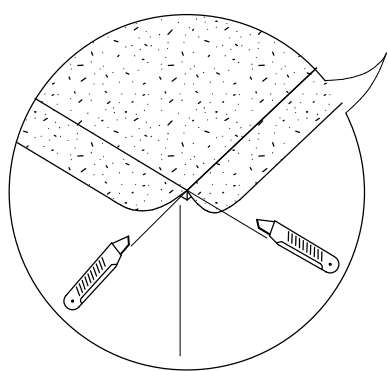

13

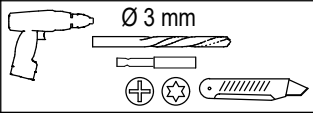

Ø 3 mm

2x

cod.

78131

6x

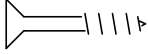

cod.

21045

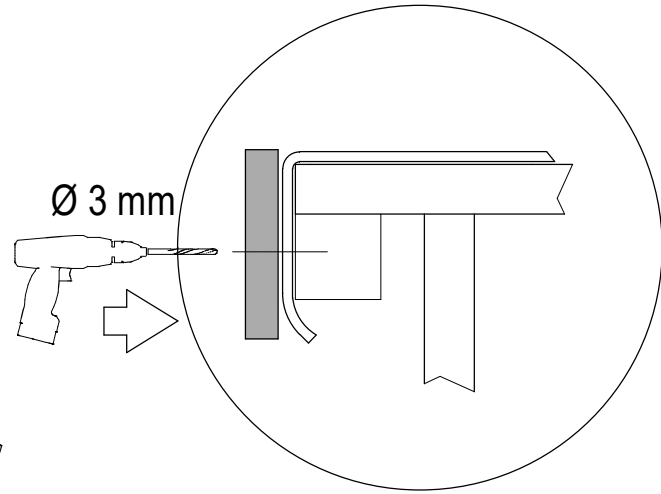
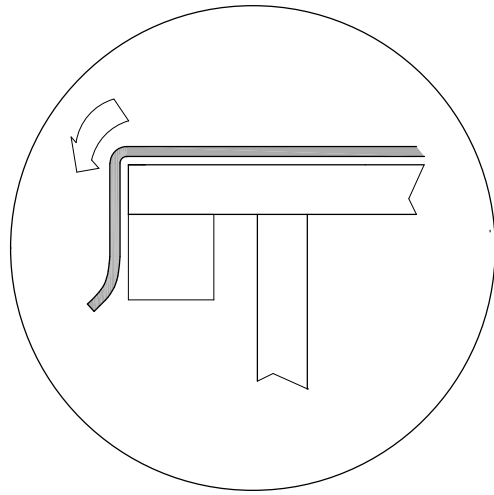
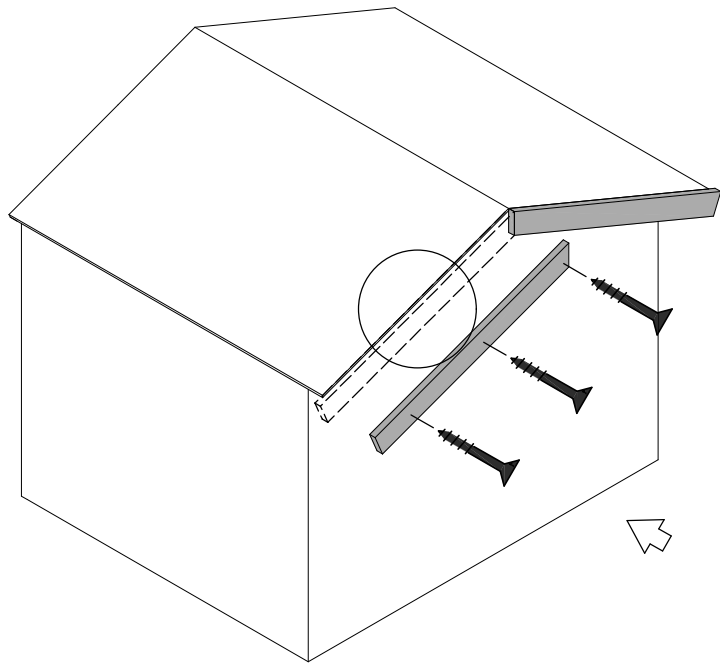

Ø 3 mm

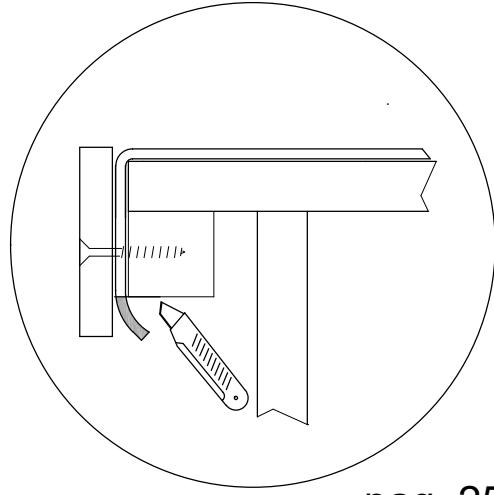
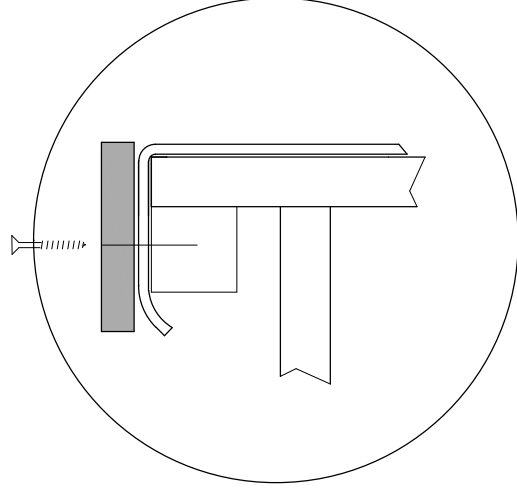

14

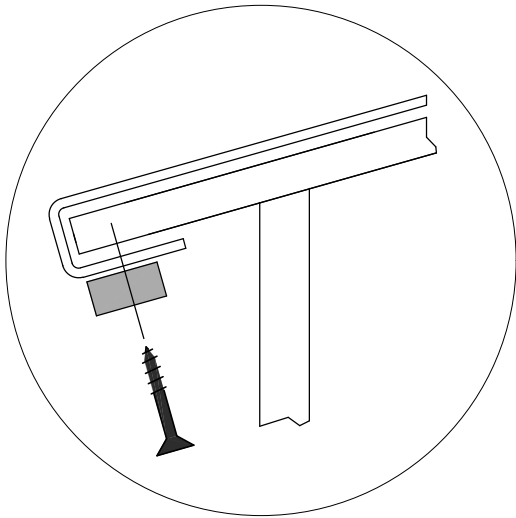
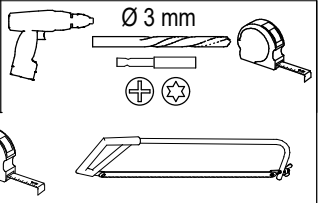

6x

cod.
82001B

28x

cod.
20027

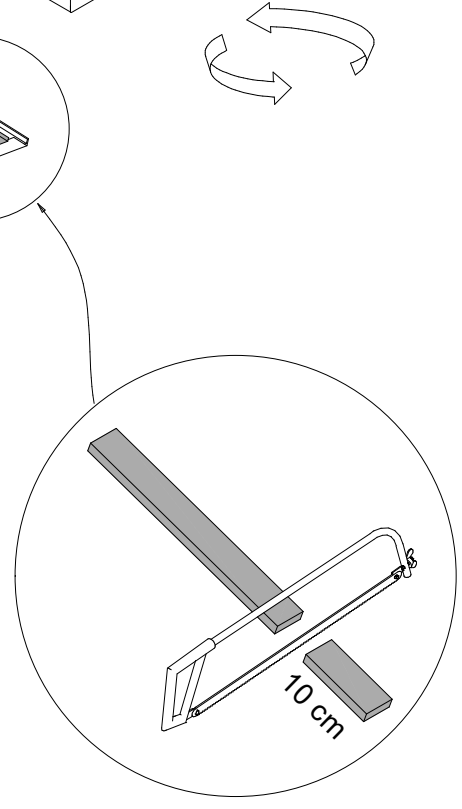
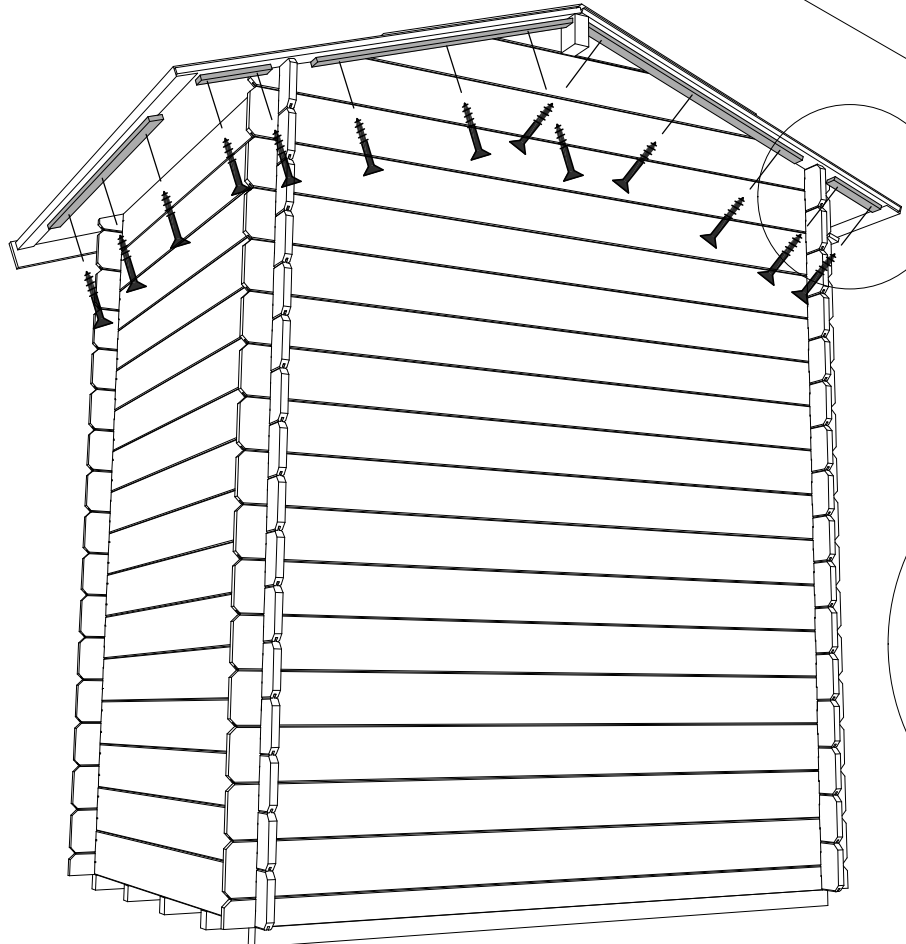
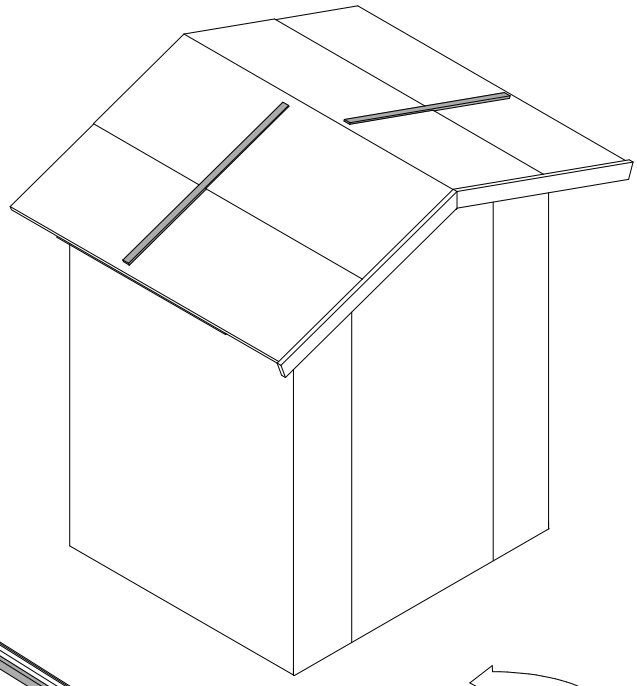
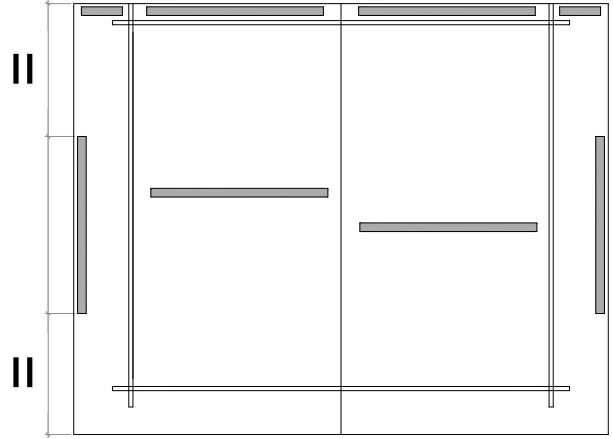

15

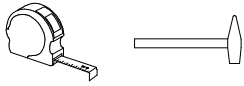

2x

B

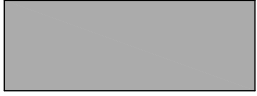

54x

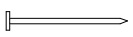

cod.
20160

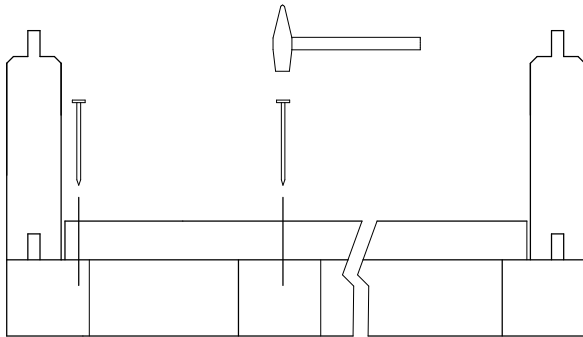
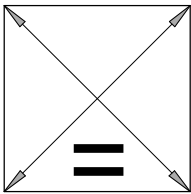

a

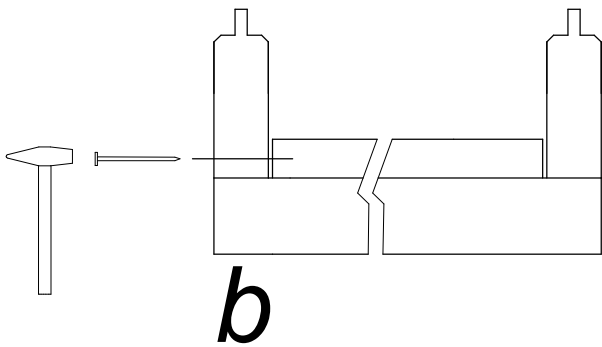

b

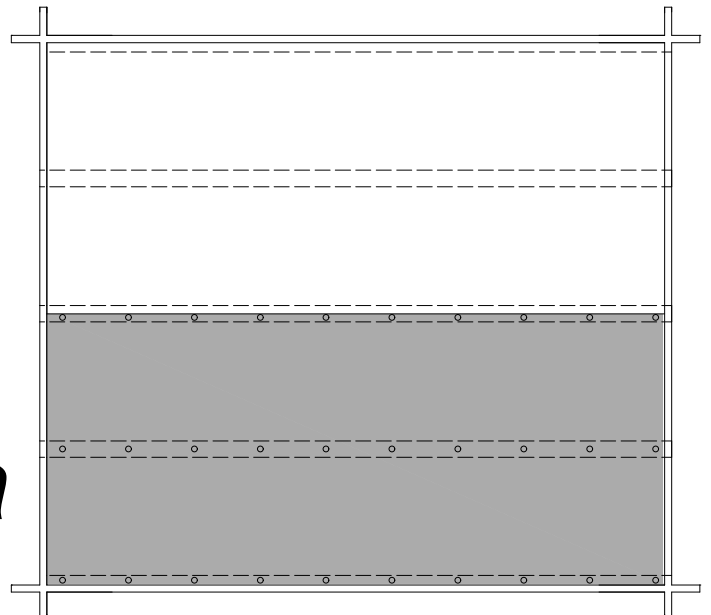
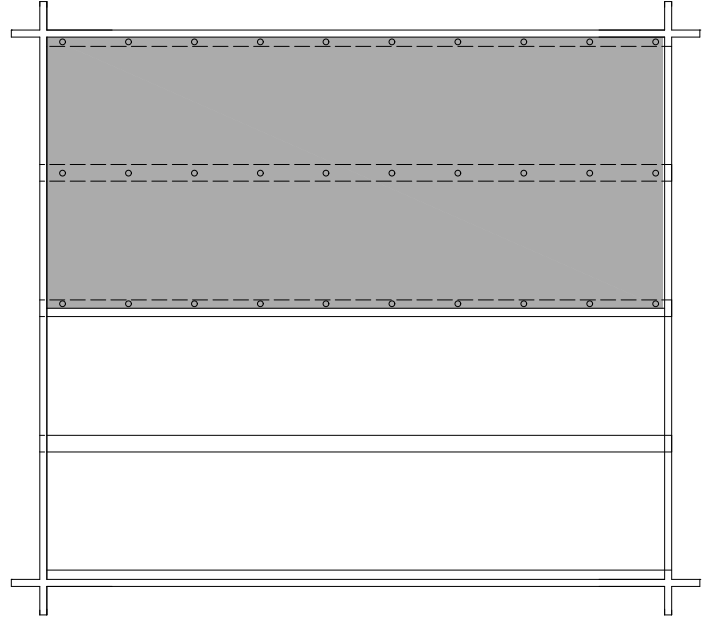

a

b

16

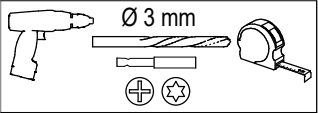

Ø 3 mm

1x **O**

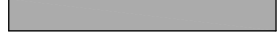

2x **P**

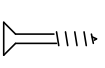

11x  cod. 20027

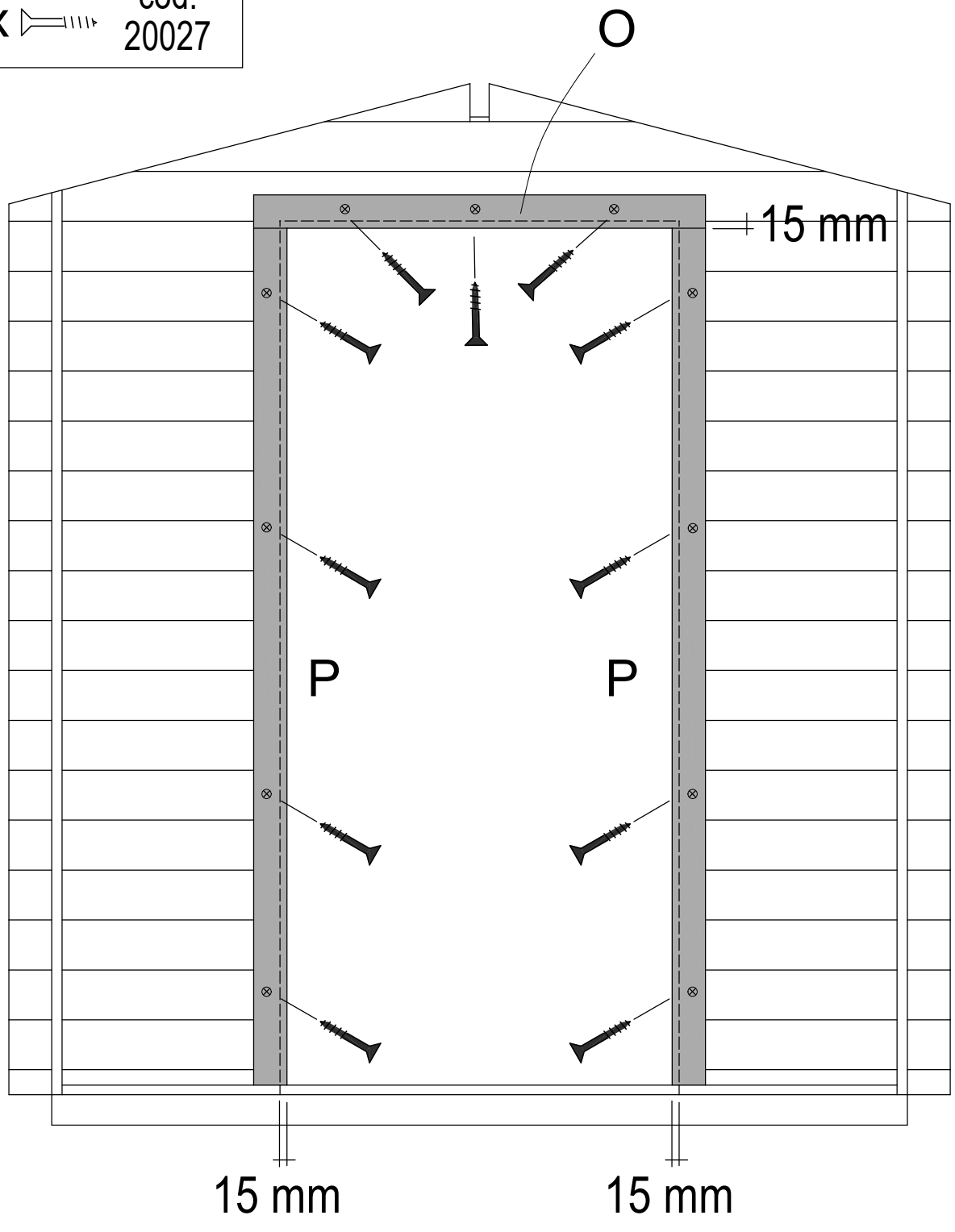
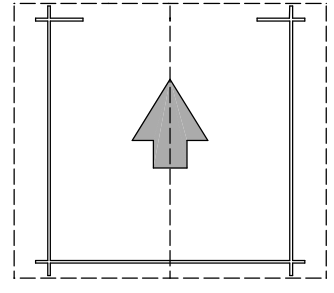

17

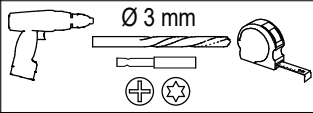

1x

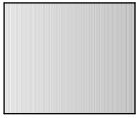

cod.
82537

1x

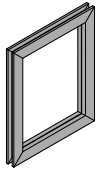

cod.
81917

1x

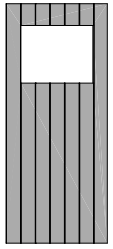

cod.
82053

8x

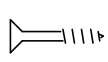

cod.
20027

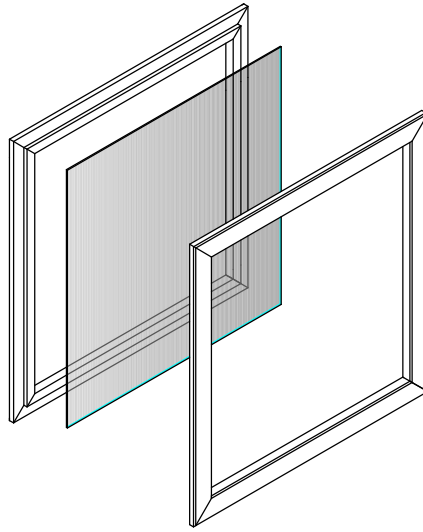
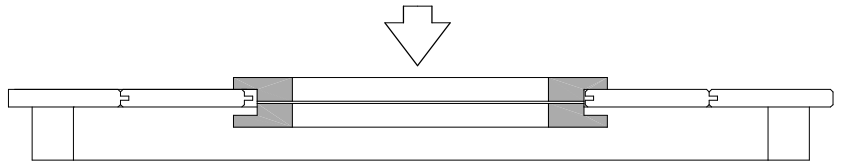

1.

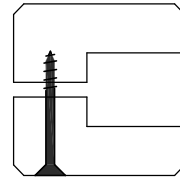

2.

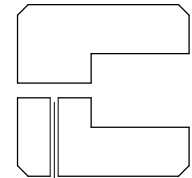

3.

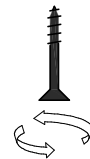

4.

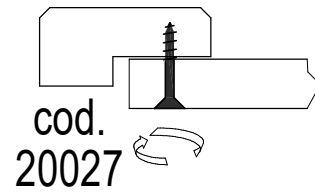

5.

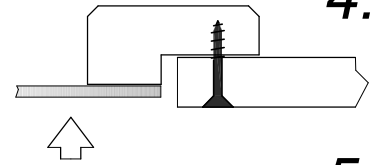

6.

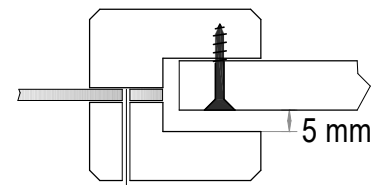

7.

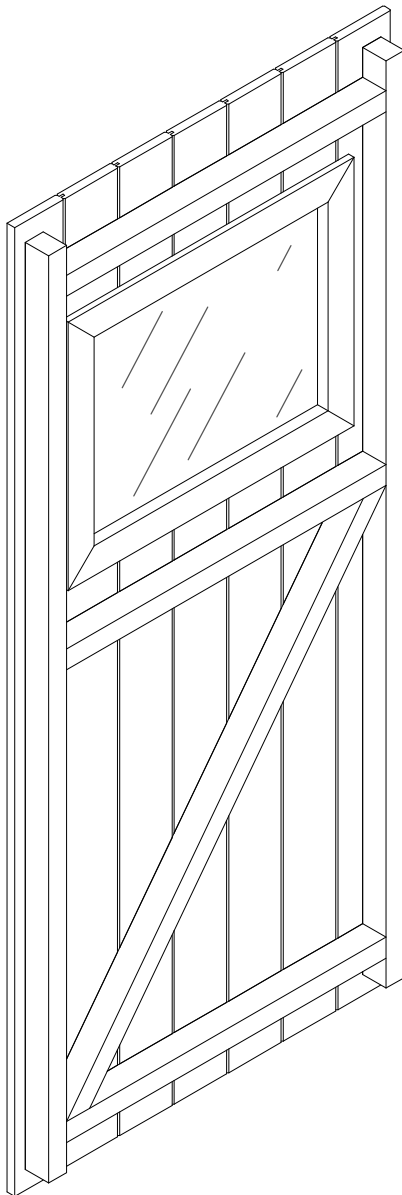
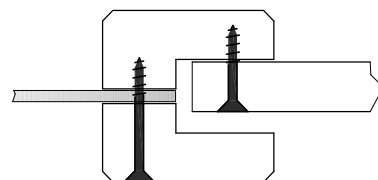
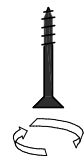
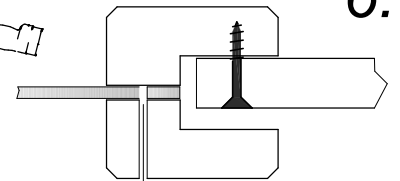
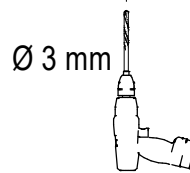

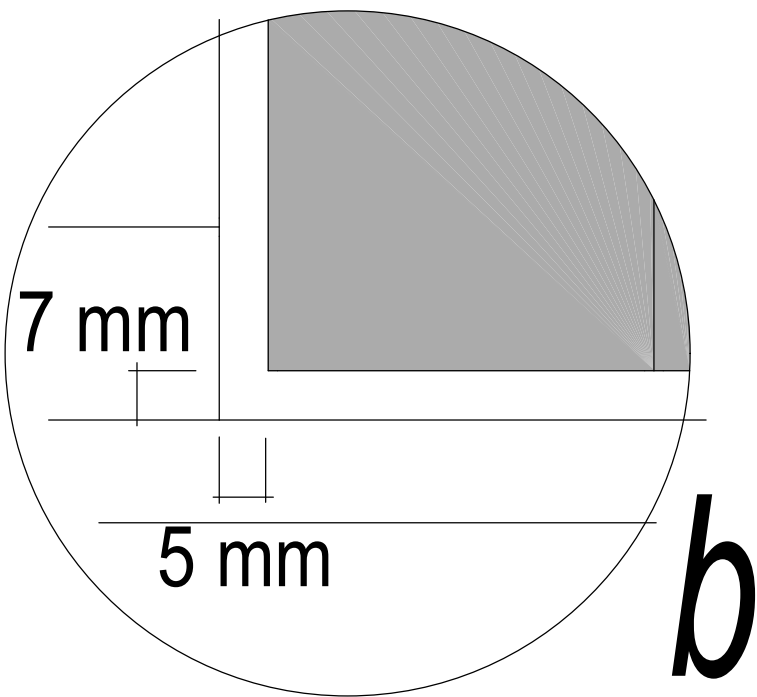
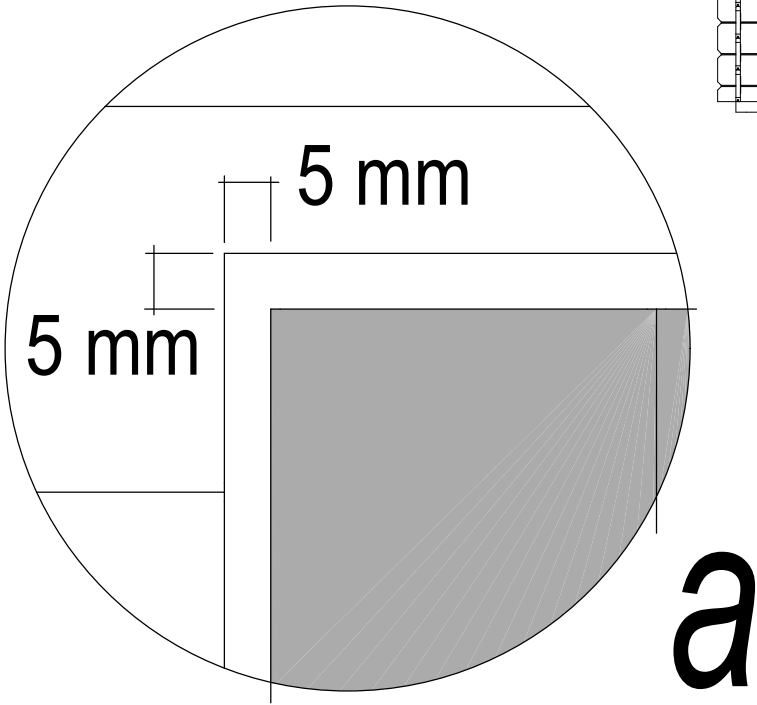
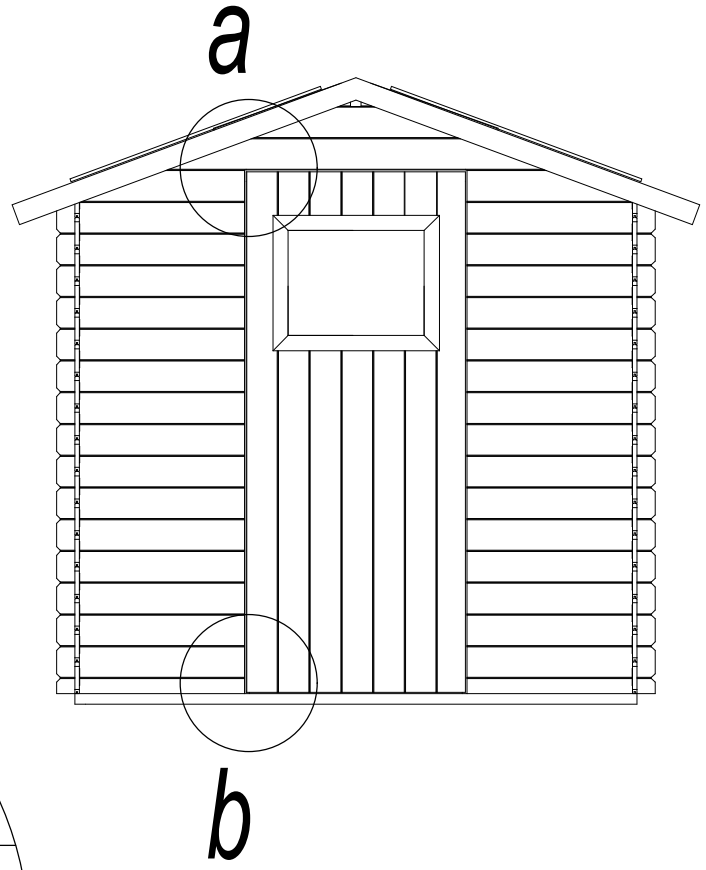
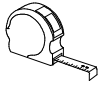

19

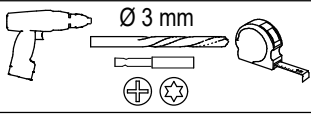

2x

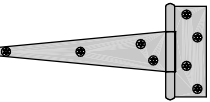

cod.
75132

16x

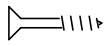

cod.
20027

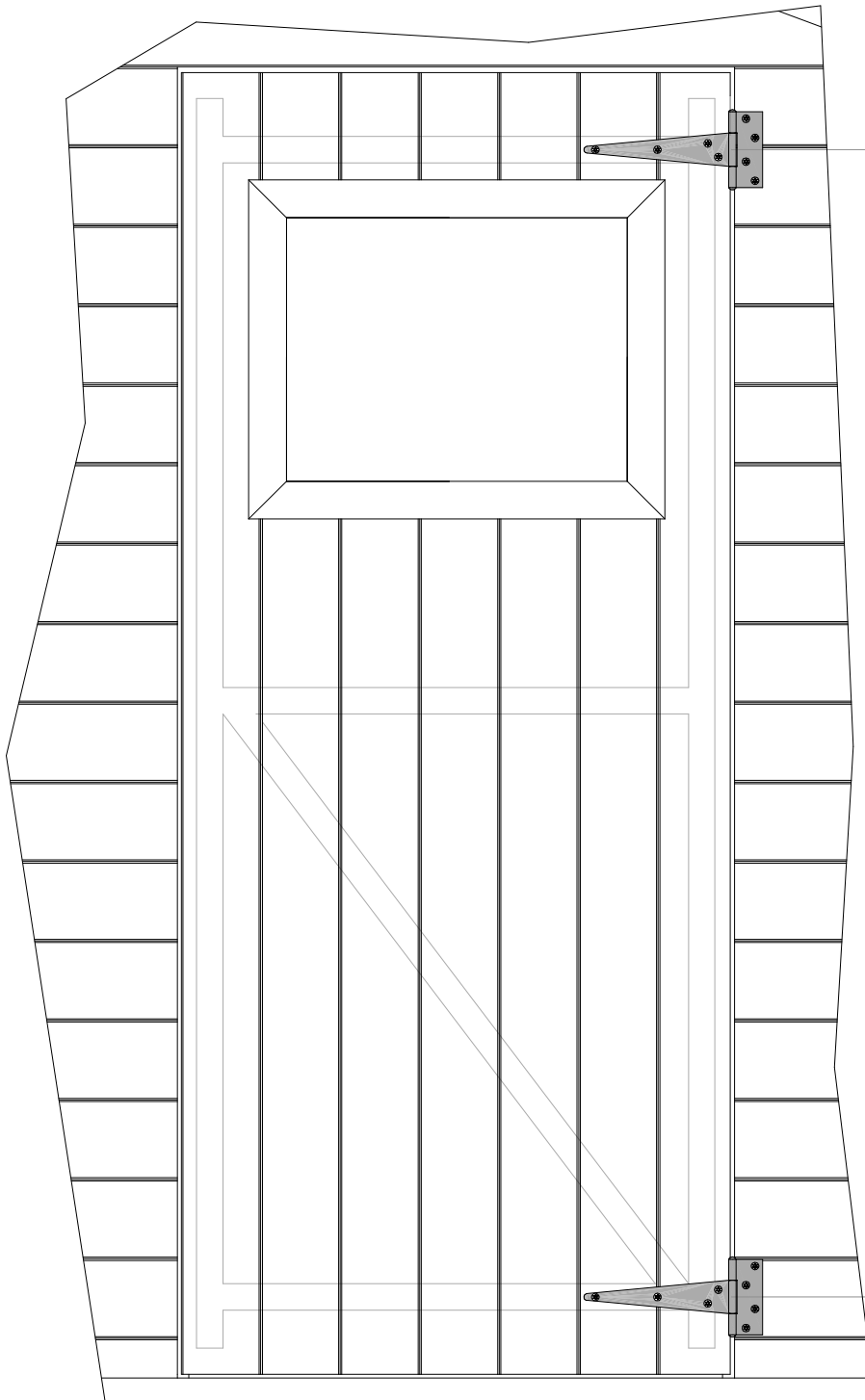
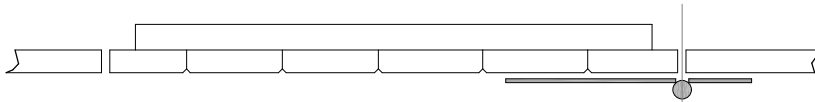
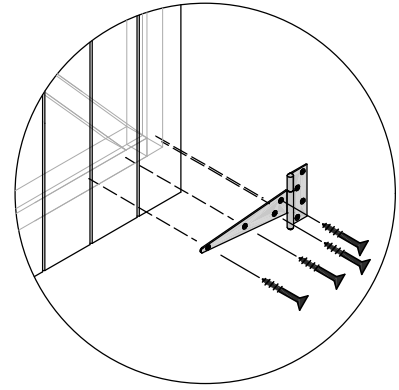
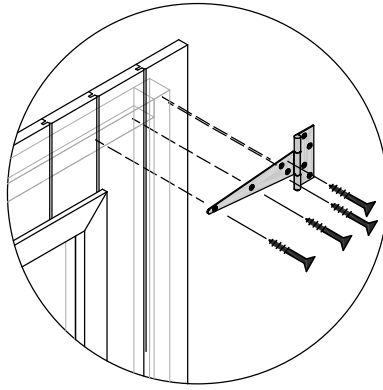

10 cm

10 cm

20

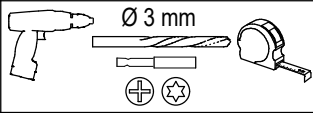

1x

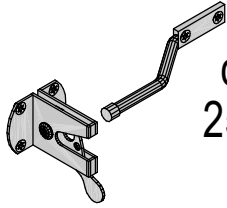

cod. 25589

6x

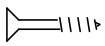

cod. 20027

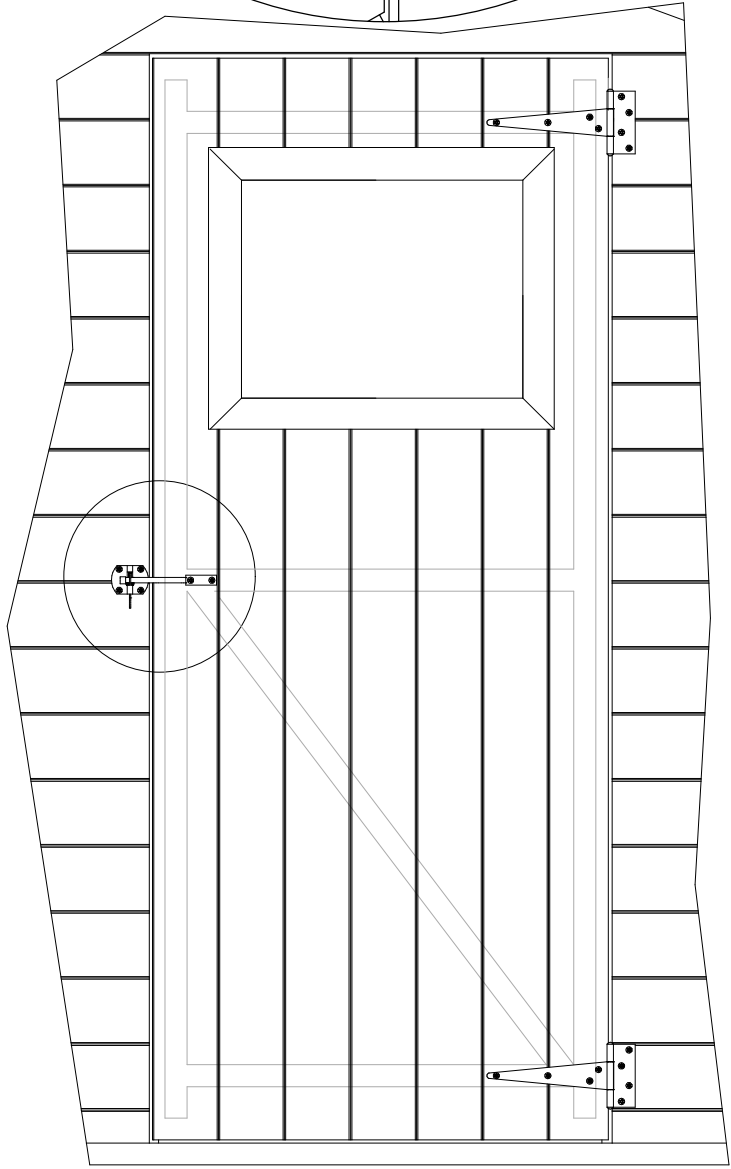
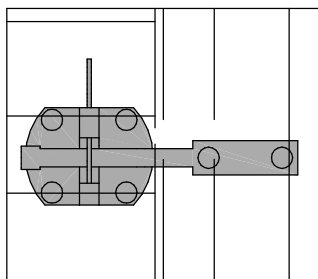
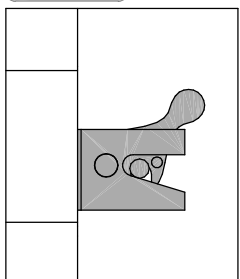
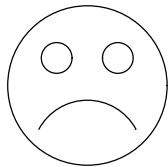
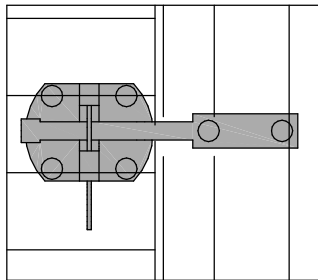
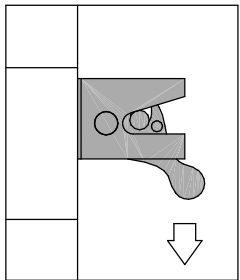
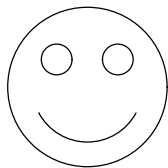
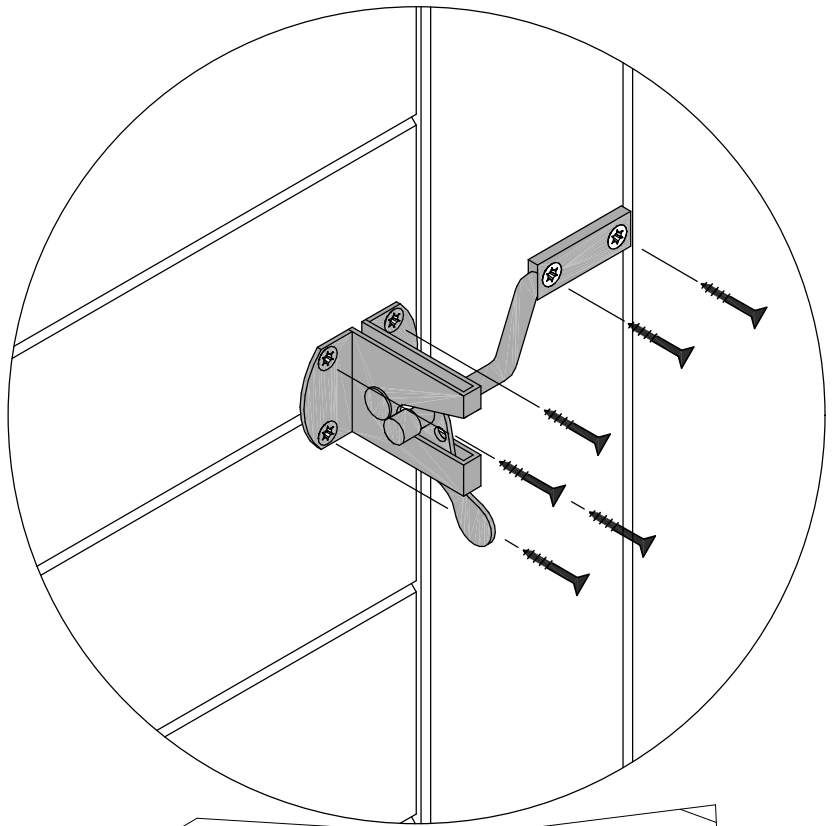

21

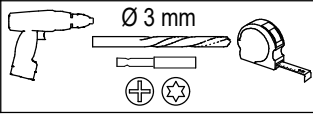

1x

N



4x

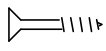

cod.
20027

1/2

1/2

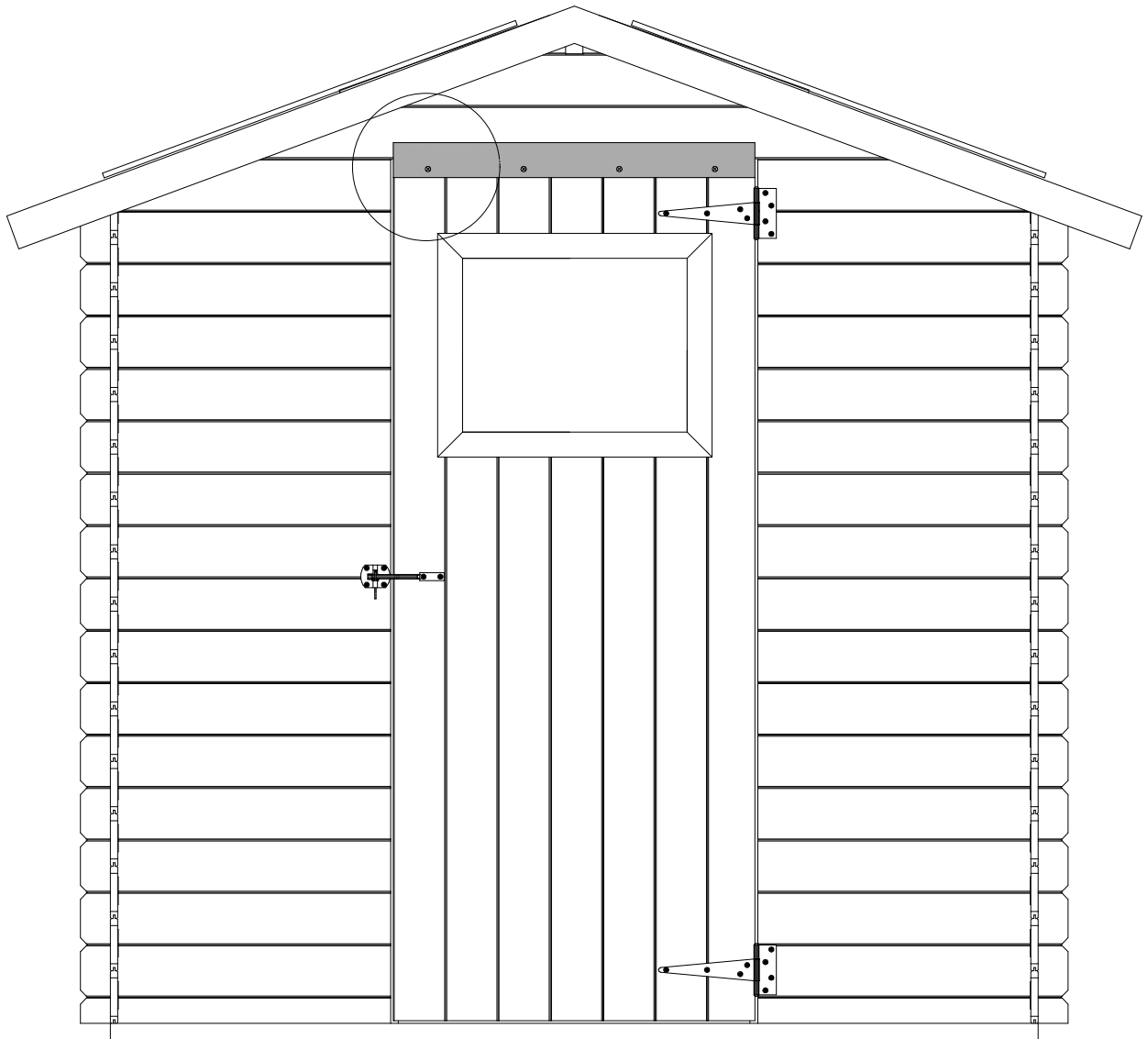
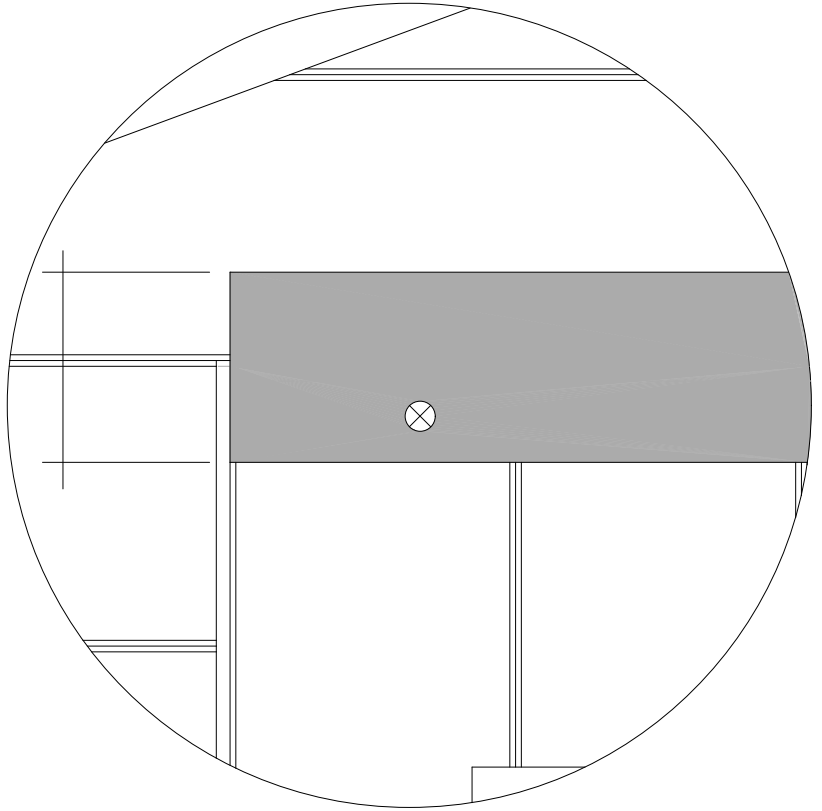

22

